

Communications Blockset™ 4

Getting Started Guide



MATLAB®
& **SIMULINK®**

How to Contact The MathWorks



www.mathworks.com Web
comp.soft-sys.matlab Newsgroup
www.mathworks.com/contact_TS.html Technical Support



suggest@mathworks.com Product enhancement suggestions
bugs@mathworks.com Bug reports
doc@mathworks.com Documentation error reports
service@mathworks.com Order status, license renewals, passcodes
info@mathworks.com Sales, pricing, and general information



508-647-7000 (Phone)



508-647-7001 (Fax)



The MathWorks, Inc.
3 Apple Hill Drive
Natick, MA 01760-2098

For contact information about worldwide offices, see the MathWorks Web site.

Communications Blockset™ Getting Started Guide

© COPYRIGHT 2001–2009 by The MathWorks, Inc.

The software described in this document is furnished under a license agreement. The software may be used or copied only under the terms of the license agreement. No part of this manual may be photocopied or reproduced in any form without prior written consent from The MathWorks, Inc.

FEDERAL ACQUISITION: This provision applies to all acquisitions of the Program and Documentation by, for, or through the federal government of the United States. By accepting delivery of the Program or Documentation, the government hereby agrees that this software or documentation qualifies as commercial computer software or commercial computer software documentation as such terms are used or defined in FAR 12.212, DFARS Part 227.72, and DFARS 252.227-7014. Accordingly, the terms and conditions of this Agreement and only those rights specified in this Agreement, shall pertain to and govern the use, modification, reproduction, release, performance, display, and disclosure of the Program and Documentation by the federal government (or other entity acquiring for or through the federal government) and shall supersede any conflicting contractual terms or conditions. If this License fails to meet the government's needs or is inconsistent in any respect with federal procurement law, the government agrees to return the Program and Documentation, unused, to The MathWorks, Inc.

Trademarks

MATLAB and Simulink are registered trademarks of The MathWorks, Inc. See www.mathworks.com/trademarks for a list of additional trademarks. Other product or brand names may be trademarks or registered trademarks of their respective holders.

Patents

The MathWorks products are protected by one or more U.S. patents. Please see www.mathworks.com/patents for more information.

Revision History

June 2001	Online only	New for Version 2.0.2 (Release 12.1)
July 2002	First printing	Revised for Version 2.5 (Release 13)
June 2004	Online only	Revised for Version 3.0 (Release 14)
October 2004	Second printing	Revised for Version 3.0.1 (Release 14SP1)
March 2005	Online only	Revised for Version 3.1 (Release 14SP2)
August 2005	Third printing	Minor Revision for Version 3.1
September 2005	Online only	Revised for Version 3.2 (Release 14SP3)
March 2006	Online only	Revised for Version 3.3 (Release 2006a)
September 2006	Online only	Revised for Version 3.4 (Release 2006b)
March 2007	Online only	Revised for Version 3.5 (Release 2007a)
September 2007	Online only	Revised for Version 3.6 (Release 2007b)
March 2008	Fourth printing	Major Revision for Version 4.0 (Release 2008a)
October 2008	Online only	Revised for Version 4.1 (Release 2008b)
March 2009	Online only	Revised for Version 4.2 (Release 2009a)
September 2009	Online only	Revised for Version 4.3 (Release 2009b)

Introduction

1

Communications Blockset Product Overview	1-2
Installing Communications Blockset Software	1-3

Building Models

2

Running a Simulink Model	2-2
Section Overview	2-2
Opening the Model	2-2
Overview of the Model	2-3
Quadrature Amplitude Modulation	2-4
Running a Simulation	2-5
Displaying the Error Rate	2-6
Setting Block Parameters	2-7
Displaying a Plot of Phase Noise	2-8
More Demos	2-10
Building a Simple Model	2-11
Section Overview	2-11
Using commstartup to Set Simulation Parameters	2-12
Opening a New Model Window	2-12
Opening Block Libraries	2-13
Moving Blocks into the Model Window	2-14
Connecting Blocks	2-15
Setting Block Parameters	2-16
Setting Simulation Parameters	2-17
Running the Model	2-18
Adding Noise to the Model	2-19
Saving a Model	2-21
Frames and Frame-Based Processing	2-22

Discrete Signals and Sample Times	2-22
Continuous Signals	2-22
Building a Channel Noise Model	2-24
Section Overview	2-24
Overview of the Model	2-24
Selecting Blocks for the Channel Noise Model	2-25
Setting Parameters in the Channel Noise Model	2-26
Connecting the Blocks	2-27
Running the Channel Noise Model	2-28
Reducing the Error Rate Using a Hamming Code	2-30
Section Overview	2-30
Building the Hamming Code Model	2-31
Using the Hamming Encoder and Decoder Blocks	2-32
Setting Parameters in the Hamming Code Model	2-32
Labeling the Display Block	2-33
Running the Hamming Code Model	2-33
Displaying Frame Sizes	2-34
Adding a Scope to the Model	2-34
Setting Parameters in the Expanded Model	2-35
Observing Channel Errors with the Scope	2-37
Modeling a Channel with Modulation	2-39
Section Overview	2-39
Building the BPSK Model	2-39
Setting Parameters in the BPSK Model	2-41
Running the BPSK Model	2-41
Reducing the Error Rate with a Cyclic Code	2-42
Section Overview	2-42
Building the Cyclic Code Model	2-42
Running the Cyclic Code Model	2-44
Verifying the Symbol Period	2-44
Using a Probe Block to Determine Symbol Period	2-45
Building a Frequency-Shift Keying Model	2-47
Section Overview	2-47
Building the FSK Model	2-48
Setting Parameters in the FSK Model	2-49
Running the FSK Model	2-50
Learning About Delays in the Model	2-51

Finding the Delay in a Model	2-51
Learning About Multirate Models	2-52
Using Sample Time Colors to Check Sample Times	2-53

Building a Convolutional Code Model	2-54
Section Overview	2-54
Building the Convolutional Code Model	2-54
Understanding the Blocks in the Model	2-55
Setting Parameters in the Convolutional Code Model	2-56
Running the Convolutional Code Model	2-57

Using Communications Blockset Software with MATLAB

3

Sending Data to the MATLAB Workspace	3-2
Section Overview	3-2
Using a Signal To Workspace Block	3-2
Configuring the Signal To Workspace Block	3-3
Viewing the Error Rate Data in the Workspace	3-3
Sending Signal and Error Data to the Workspace	3-4
Viewing the Signal and Error Data in the Workspace	3-5
Analyzing Signal and Error Data	3-6
Running Simulations from the Command Line	3-7
Section Overview	3-7
Running a Single Simulation	3-7
Running Multiple Simulations	3-8
Plotting the Results of Multiple Simulations	3-10
Running Multiple Simulations Using BERTool	3-10
Importing Data from the MATLAB Workspace	3-13
Section Overview	3-13
Simulating a Signal by Importing Data	3-13
Simulating Noise with Imported Data	3-14
Simulating Noise with Specified Error Patterns	3-15
Setting Sample Times and Samples per Frame	3-16
Learning More	3-19

Online Help	3-19
Demos	3-19
The MathWorks Online	3-20

List of Examples

A

Getting Started	A-2
-----------------------	-----

Index

Introduction

- “Communications Blockset Product Overview” on page 1-2
- “Installing Communications Blockset Software” on page 1-3

Communications Blockset Product Overview

The Communications Blockset product extends Simulink® software with a comprehensive library of blocks to design and simulate the physical layer of communication systems and components. The blockset helps you design communications systems and their semiconductor components, such as commercial or defense wireless and wireline systems.

The key features of the blockset are

- Blocks for designing and simulating the physical layer of communications systems, including modulation, source and channel encoding, channels, and equalization
- The ability to tune models and visualize the results
- Hierarchical, block-based models for visually conveying complex designs
- Integration with Communications Toolbox™ software for postsimulation analysis

Installing Communications Blockset Software

To build and run the models in this manual, you must first install Communications Blockset™ software and the products it requires, which are listed below:

- MATLAB® Software
- Simulink Software
- Signal Processing Toolbox™ Software
- Communications Toolbox Software
- Signal Processing Blockset™ Software

You can find instructions for installing these products in the MATLAB installation documentation for your platform. To determine what products are installed on your system, enter `ver` in the MATLAB Command Window. This displays information about the version of MATLAB you are running, including a list of all toolboxes and blocksets installed on your system.

Building Models

This chapter introduces you to Simulink and Communications Blockset software. The chapter begins by showing you how to run an existing Simulink model and how to build a simple model. It then explains how to build typical models of communication systems using Communications Blockset software. These models show you how to use the blockset and illustrate some of its important features.

- “Running a Simulink Model” on page 2-2
- “Building a Simple Model” on page 2-11
- “Building a Channel Noise Model” on page 2-24
- “Reducing the Error Rate Using a Hamming Code” on page 2-30
- “Modeling a Channel with Modulation” on page 2-39
- “Reducing the Error Rate with a Cyclic Code” on page 2-42
- “Building a Frequency-Shift Keying Model” on page 2-47
- “Building a Convolutional Code Model” on page 2-54

Running a Simulink Model

In this section...
“Section Overview” on page 2-2
“Opening the Model” on page 2-2
“Overview of the Model” on page 2-3
“Quadrature Amplitude Modulation” on page 2-4
“Running a Simulation” on page 2-5
“Displaying the Error Rate” on page 2-6
“Setting Block Parameters” on page 2-7
“Displaying a Plot of Phase Noise” on page 2-8
“More Demos” on page 2-10

Section Overview

This section describes a demo model of a communications system that comes with Communications Blockset software. The model displays a scatter plot of a signal with added noise. The purpose of this section is to familiarize you with the basics of Simulink models and how they function.

The section takes you through some key elements of working with this model.

Opening the Model

To open the model, first start MATLAB. In the MATLAB Command Window, enter `commphasenoise` at the prompt. This opens the model in a new window, as shown in the following figure.

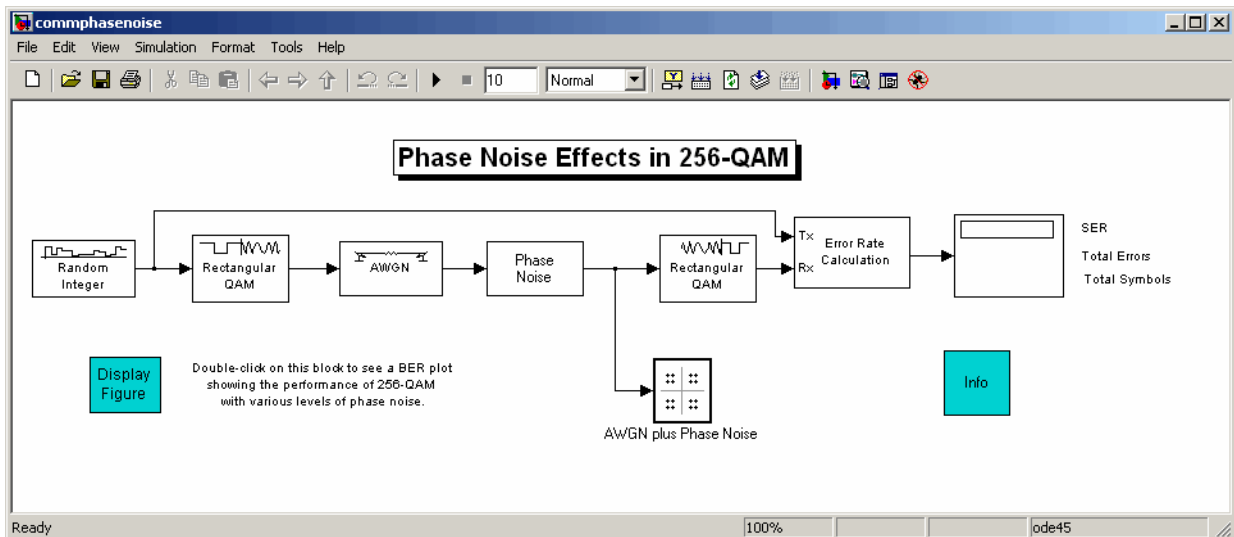

Overview of the Model

The Simulink model shown in the preceding section, “Opening the Model” on page 2-2, simulates the effect of phase noise on quadrature amplitude modulation (QAM) of a signal. The Simulink model is a graphical representation of a mathematical model of a communication system that generates a random signal, modulates it using QAM, and adds noise to simulate a channel. The model also contains components for displaying the symbol error rate and a scatter plot of the modulated signal.

The blocks and lines in the Simulink model describe mathematical relationships among signals and states:

- The Random Integer Generator block, labeled Random Integer, generates a signal consisting of a sequence of random integers between zero and 255
- The Rectangular QAM Modulator Baseband block, to the right of the Random Integer Generator block, modulates the signal using baseband 256-ary QAM.
- The AWGN Channel block models a noisy channel by adding white Gaussian noise to the modulated signal.

- The Phase Noise block introduces noise in the angle of its complex input signal.
- The Rectangular QAM Demodulator Baseband block, to the right of the Phase Noise block, demodulates the signal.

In addition, the following blocks in the model help you interpret the simulation:

- The Discrete-Time Scatter Plot Scope block, labeled AWGN plus Phase Noise, displays a scatter plot of the signal with added noise.
- The Error Rate Calculation block counts symbols that differ between the received signal and the transmitted signal.
- The Display block, at the far right of the model window, displays the symbol error rate (SER), the total number of errors, and the total number of symbols processed during the simulation.

All these blocks are included in Communications Blockset and Simulink applications. You can find more detailed information about these blocks by right-clicking the block and selecting **Help** from the context menu.

Quadrature Amplitude Modulation

This model simulates quadrature amplitude modulation (QAM), which is a method for converting a digital signal to a complex signal. The model modulates the signal onto a sequence of complex numbers that lie on a lattice of points in the complex plane, called the *constellation* of the signal. The constellation for baseband 256-ary QAM is shown in the following figure.

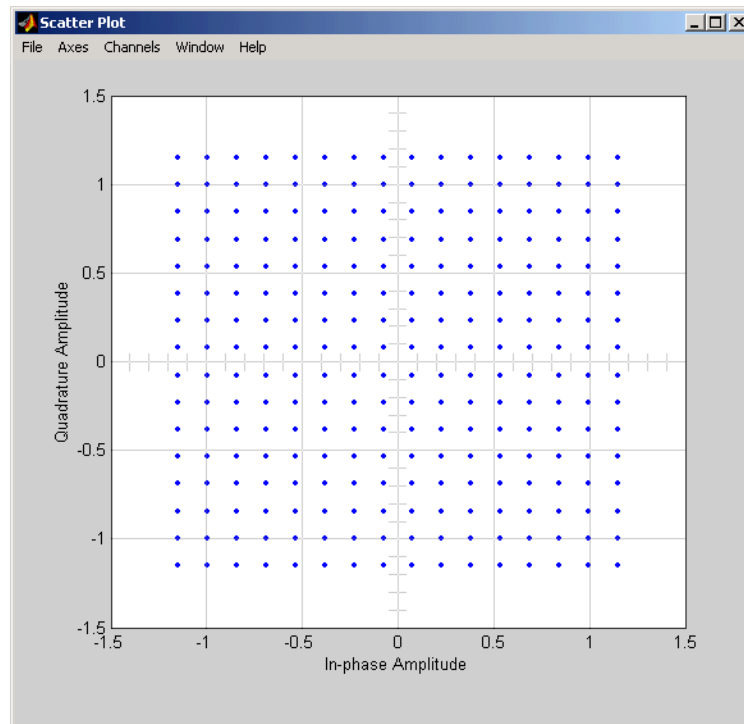

Constellation for 256-ary QAM

Running a Simulation

To run a simulation, select **Simulation > Start** from the top of the model window. The simulation stops automatically at the **Stop time**, which is specified in the **Configuration Parameters** dialog box. You can stop the simulation at any time by selecting **Stop** from the **Simulation** menu at the top of the model window (or, on Microsoft Windows, by clicking the **Stop** button on the toolbar).

When you run the model, a new window appears, displaying a scatter plot of the modulated signal with added noise, as shown in the following figure.

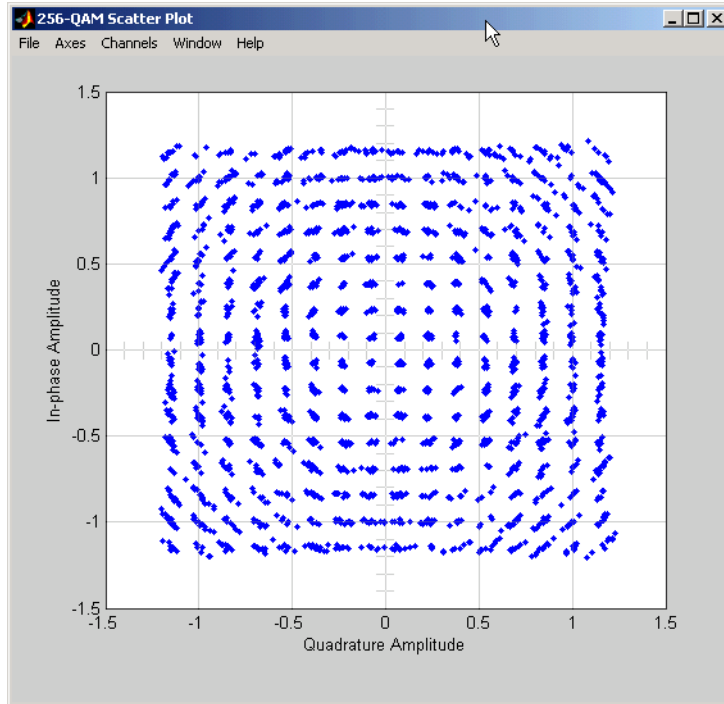

Scatter Plot of Signal Plus Noise

The points in the scatter plot do not lie exactly on the constellation shown in the figure Constellation for 256-ary QAM on page 2-5 because of the added noise. The radial pattern of points is due to the addition of phase noise, which alters the angle of the complex modulated signal.

Displaying the Error Rate

The Display block displays the number of errors introduced by the channel noise. When you run the simulation, three small boxes appear in the block, as shown in the following figure, displaying the vector output from the Error Rate Calculation block.

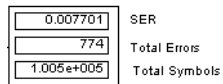

Error Rate Display

The block displays the output as follows:

- The first entry is the symbol error rate (SER).
- The second entry is the total number of errors.
- The third entry is the total number of comparisons made. The notation $1e+004$ is shorthand for 10^4 .

Setting Block Parameters

You can control the way a Simulink block functions by setting its parameters. To view or change a block's parameters, double-click the block. This opens a dialog box, sometimes called the block's *mask*. For example, the dialog box for the Phase Noise block is shown in the following figure.

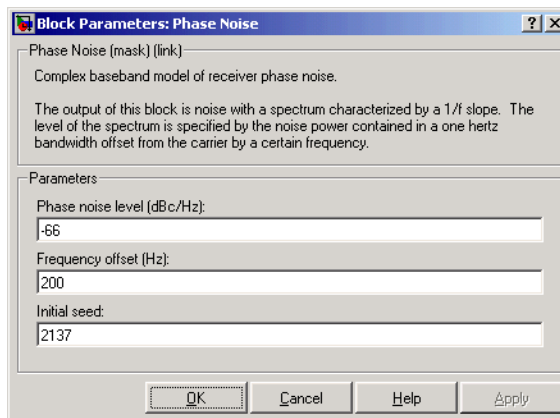

Dialog for the Phase Noise Block

To change the amount of phase noise, click in the **Phase noise level (dBc/Hz)** field and enter a new value. Then click **OK**.

Alternatively, you can enter a variable name, such as `phasenoise`, in the field. You can then set a value for that variable in the MATLAB Command Window, for example by entering `phasenoise = 2`. Setting parameters in the Command Window is convenient if you need to run multiple simulations with different parameter values. See the section “Running Multiple Simulations” on page 3-8.

You can also change the amount of noise in the AWGN Channel block. Double-click the block to open its dialog box, and change the value in the **Es/No** parameter field. This changes the signal to noise ratio, in dB. Decreasing the value of **Es/No** increases the noise level.

You can experiment with the model by changing these or other parameters and then running a simulation. For example,

- Change **Phase noise level (dBc/Hz)** to -150 in the dialog box for the Phase Noise block.
- Change **Es/No** to 100 in the dialog for the AWGN Channel block.

This removes nearly all noise from the model. When you now run a simulation, the scatter plot appears as in the figure Constellation for 256-ary QAM on page 2-5.

Displaying a Plot of Phase Noise

Double-click the block labeled “Display Figure” at the bottom left of the model window. This displays a plot showing the results of multiple simulations.

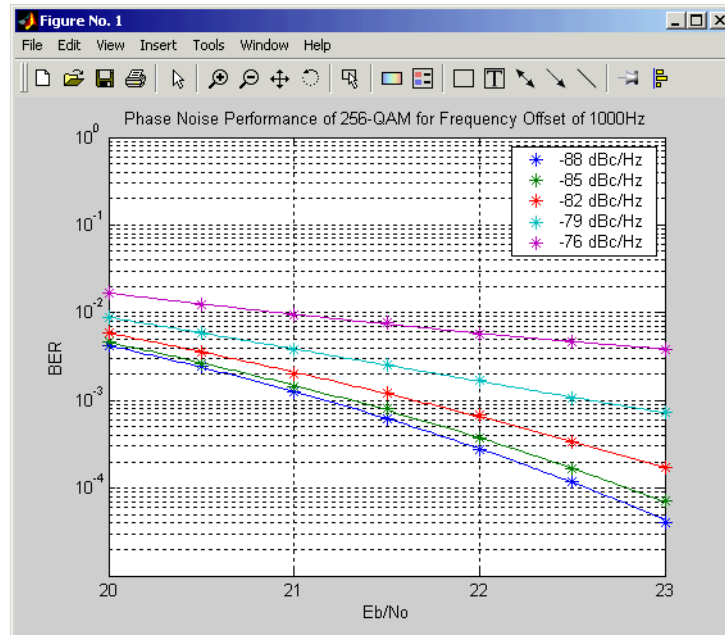

Plot of BER at Different Noise Levels

Each curve is a plot of bit error rate as a function of signal to noise ratio for a fixed amount of phase noise.

You can create plots like this by running multiple simulations with different values for the **Phase noise level (dBc/Hz)** and **E_s/N_0** parameters. “Running Multiple Simulations” on page 3-8 describes how to do this with a MATLAB script, using variables for the parameters.

More Demos

You can find Communications Blockset demos in the MATLAB Help browser.

- 1 To open the Help browser, type `doc` at the MATLAB command line.
- 2 To see a list of demo categories, expand the **Communications Blockset** node in the Help browser, then click the **Demos** node.

The Communications Blockset display in the Help browser.

You can find more demos for the Simulink software by typing `demo` at the MATLAB command line.

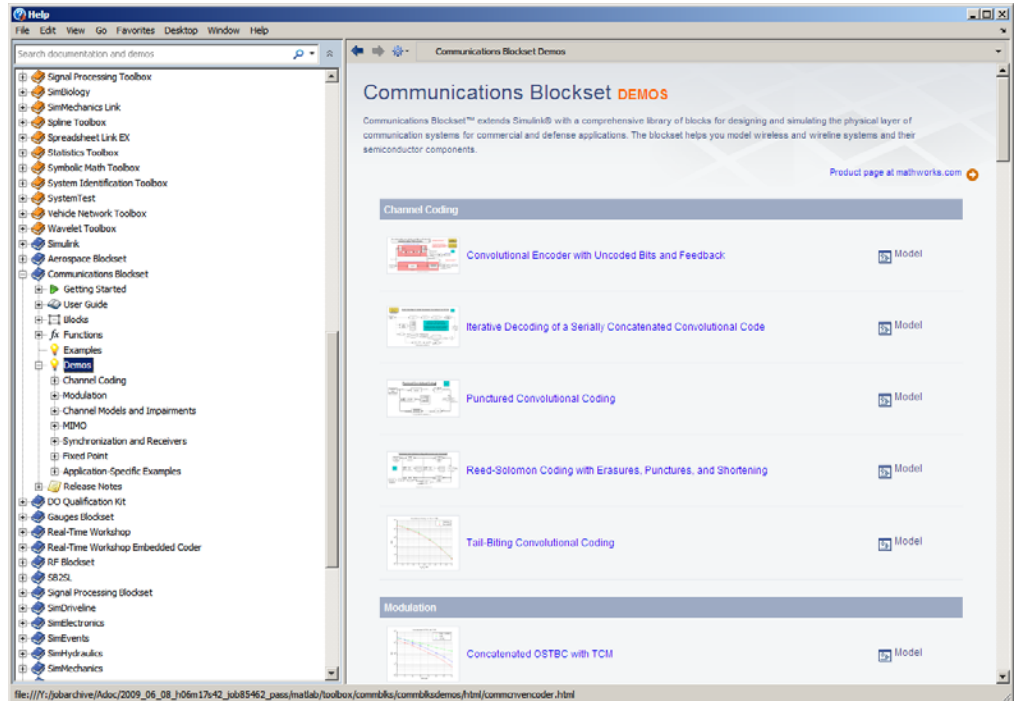

Building a Simple Model

In this section...

“Section Overview” on page 2-11

“Using commstartup to Set Simulation Parameters” on page 2-12

“Opening a New Model Window” on page 2-12

“Opening Block Libraries” on page 2-13

“Moving Blocks into the Model Window” on page 2-14

“Connecting Blocks” on page 2-15

“Setting Block Parameters” on page 2-16

“Setting Simulation Parameters” on page 2-17

“Running the Model” on page 2-18

“Adding Noise to the Model” on page 2-19

“Saving a Model” on page 2-21

“Frames and Frame-Based Processing” on page 2-22

“Discrete Signals and Sample Times” on page 2-22

“Continuous Signals” on page 2-22

Section Overview

In the previous section, you ran a model that was already built. This section explains how to build a simple Simulink model that displays a sine wave in a scope.

Building a model usually involves several iterations, as you decide which blocks to include and what parameter settings to make. In the example in this section, you refine the model by adding noise.

For more detailed information on building models, see the Simulink documentation.

Using commstartup to Set Simulation Parameters

Before starting to build the model, enter

```
commstartup
```

at the MATLAB prompt.

This

- Sets the Simulink **Boolean logic signals** parameter to Off
- Sets default simulation parameters that are optimal for communications models

Communications Blockset software does not support signals with Boolean data types. If you want to use Simulink blocks that output Boolean data types, such as the Logical Operator block, in a model with blocks from Communications Blockset software, enter `commstartup` before building the model. The `commstartup` settings apply to any models you create during the current MATLAB session. You must enter `commstartup` at the beginning of each MATLAB session to establish these settings.

If you build a model without entering `commstartup` and subsequently decide to use Simulink blocks that output signals with Boolean data types, turn off the model's **Boolean logic signals** parameter by entering

```
set_param('my_model', 'BooleanDataType', 'off')
```

where `my_model.mdl` is the name of the model.

Opening a New Model Window

The first step in building a model is to open a new model window. To do so, select **File > New > Model**, and then select **Model**. This opens an empty model window, as shown in the following figure.

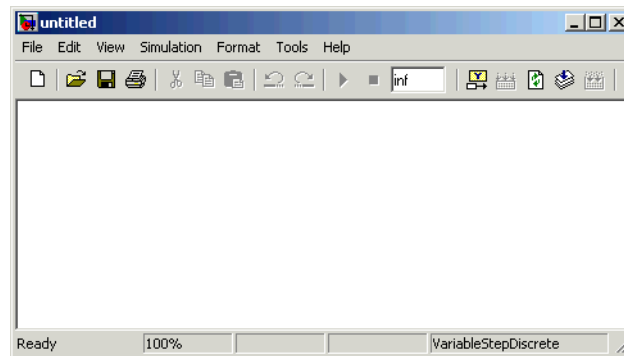

Opening Block Libraries

The next step is to select the blocks for the model. These blocks are contained in libraries. To view the libraries for the products you have installed, type `simulink` at the MATLAB prompt (or click the Simulink button  on the MATLAB toolbar). The Simulink Library Browser appears.

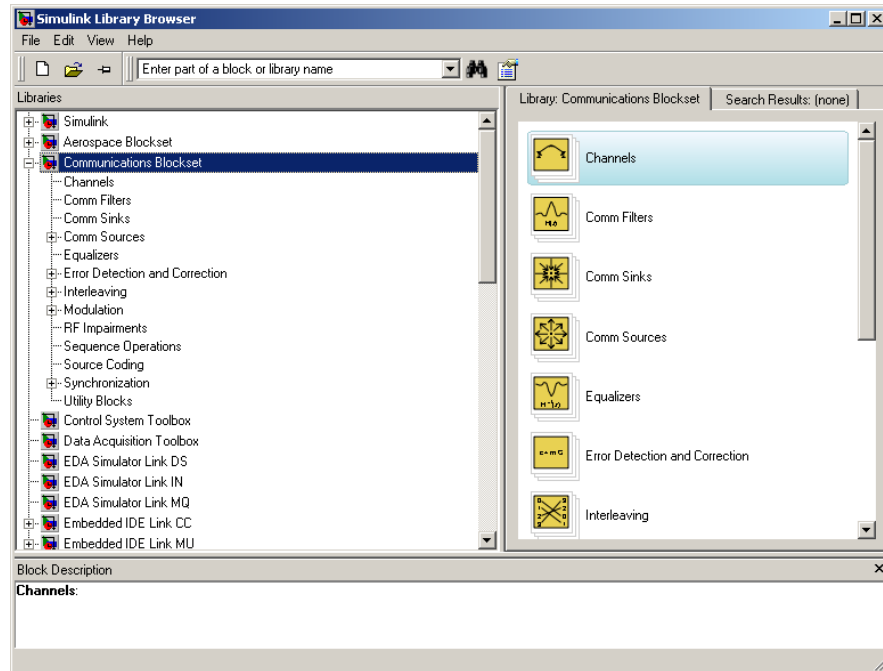

Simulink Library Browser

The left pane displays the installed products, each of which has its own library of blocks. To open a library, click the + sign next to the name of the blockset in the left pane. This displays the contents of the library in the right pane.

You can find the blocks you need to build models of communication systems in Communications Blockset, Signal Processing Blockset, and Simulink libraries.

Moving Blocks into the Model Window

The next step in building the model is to move blocks from the Simulink Library Browser into the model window. To do so,

- 1 Click the + sign next to **Signal Processing Blockset** in the left pane of the Library Browser. This displays a list of the Signal Processing Blockset libraries.

- 2 Click **Signal Processing Sources** in the left pane. This displays a list of the Signal Processing Sources library blocks in the right pane. If you do not see the Sine Wave block, scroll down the list until it is visible.
- 3 Click the Sine Wave block and drag it into the model window.
- 4 Click **Signal Processing Sinks** in the left pane of the Library Browser.
- 5 Scroll down in the right pane of the Library Browser until you see the Vector Scope block, and drag the block into the model window to the right of the Sine Wave block.

Once a block is in the model window, you can move it to another position by dragging the block with the mouse.

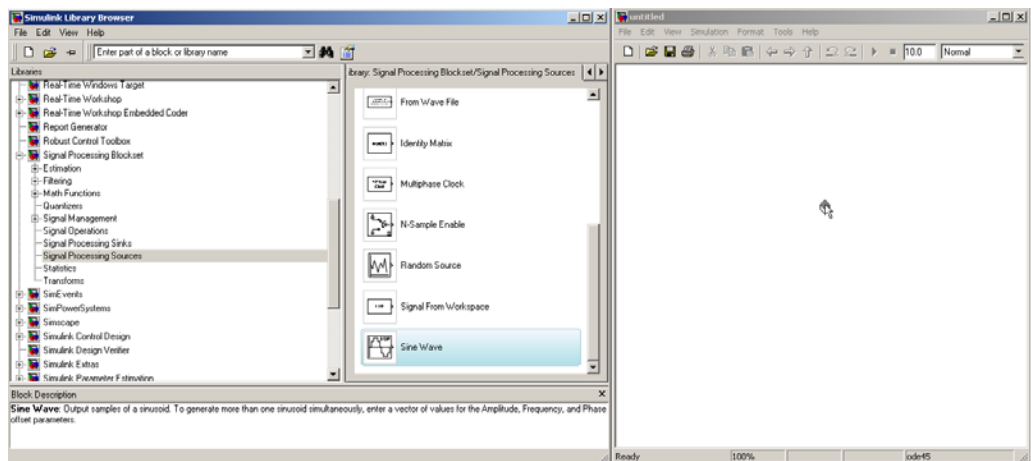

Dragging a Block into a Model Window

Connecting Blocks

The small arrowhead pointing outward from the right side of the Sine Wave block is an output port for the data the block generates. The arrowhead pointing inward on the Vector Scope block is an input port. To connect the two blocks, click the output port of the Sine Wave block and drag the mouse toward the input port of the Vector Scope block, as shown in the following figure.

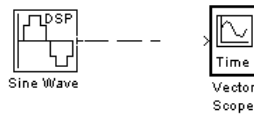

When the pointer is on the input port of the Vector Scope block, release the mouse button. You should see a solid arrow appear, as in the following figure.

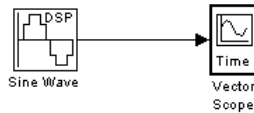

If you do not see a solid arrowhead, you have not made a connection. In this case, click the arrowhead again, drag it all the way to the Vector Scope's input port, and release the mouse button.

Setting Block Parameters

To set parameters for the Sine Wave block, double-click the block to open its dialog box, as shown in the following figure. Change the following parameters by clicking in the field next to the parameter, deleting the default setting, and entering the new setting in its place:

- 1 Set **Amplitude** to 5.
- 2 Set **Frequency** to 30.
- 3 Set **Samples per frame** to 100.
- 4 Click **OK**.

Note You must set **Samples per frame** to a value larger than 1 to see an image of the sine wave in the Scope block.

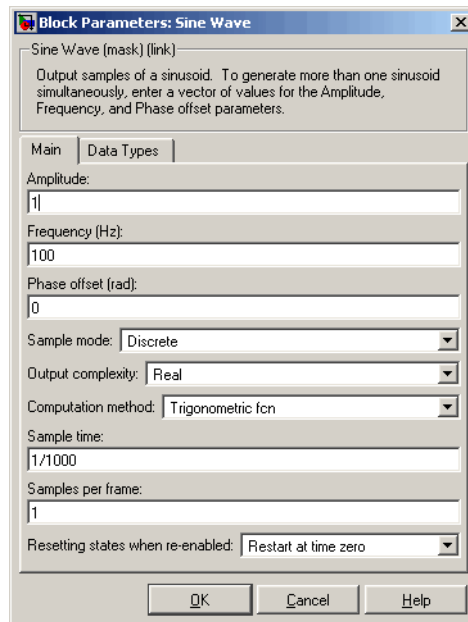

Dialog Box for the Sine Wave Block

Setting Simulation Parameters

In addition to individual block parameters, the model also has overall simulation parameters. To view the current settings,

- 1 Select the **Simulation** menu at the top of the model window.
- 2 Select **Configuration parameters** to open the **Configuration Parameters** dialog box, as shown in the following figure.

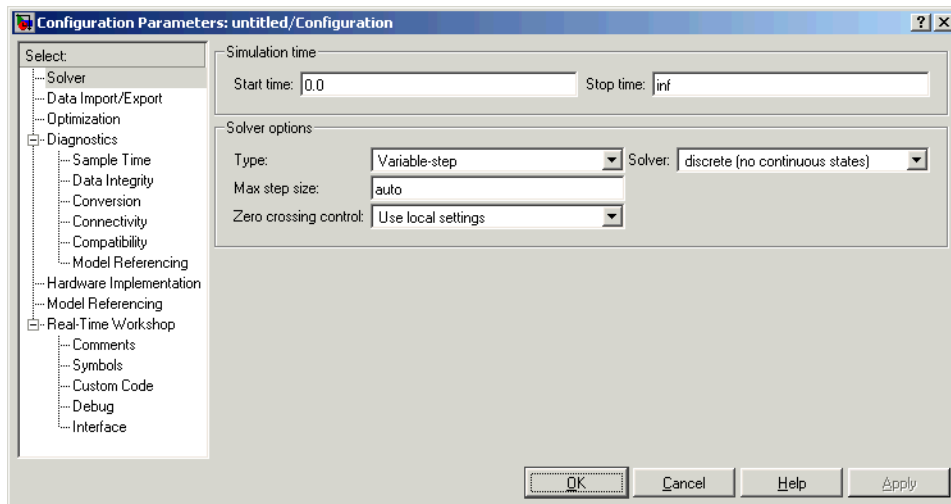

Configuration Parameters Dialog Box

If you typed `commstartup` before creating the model, the **Stop time** should be set to `inf`. The **Stop time** determines the time at which the simulation ends. Setting **Stop time** to `inf` causes the simulation to run indefinitely, until you stop it by selecting **Stop** from the **Simulation** menu.

The **Stop time** is not the actual time it takes to run a simulation. The actual run time for a simulation depends on factors such as the model's complexity and your computer's clock speed.

The settings in the **Configuration Parameters** dialog box affect only the parameters of the current model.

Note To conserve memory in a model, click **Data Import/Export** on the left, and clear the boxes next to **Time** and **Output** under **Save to workspace** on the right.

Running the Model

Run the model by selecting **Simulation > Start**. When you do so, a scope window appears, displaying a sine wave, as shown in the following figure.

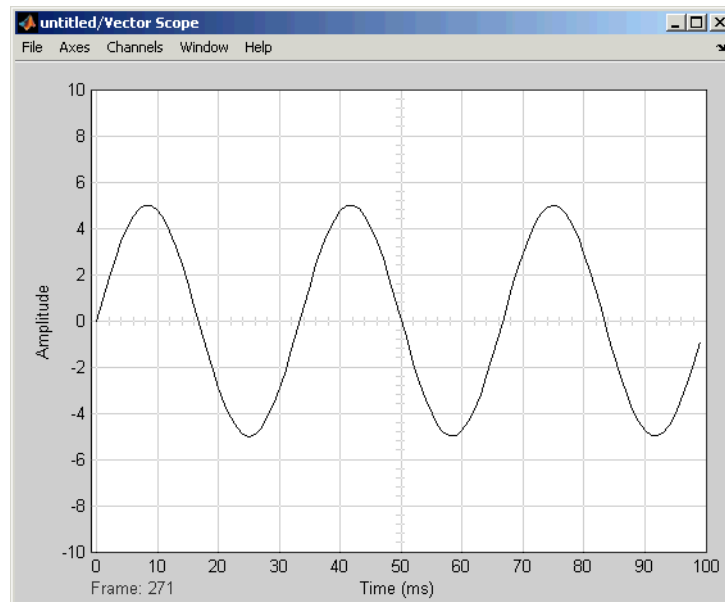

Sine Wave Displayed in a Scope

Note If you do not see the sine wave in the scope, make sure that the **Samples per frame** parameter for the Sine Wave block is set to 100.

When you are finished observing the simulation, select **Simulation > Stop**.

Adding Noise to the Model

You can add noise to the model using the AWGN Channel block, from the Channels library of Communications Blockset software. The block adds white Gaussian noise to the sine wave. Move the block from the Simulink Library Browser into the model window, as described in “Moving Blocks into the Model Window” on page 2-14. You can add the block to the model as follows:

- 1 Extend the line between the Sine Wave block and the Vector Scope block by dragging the Vector Scope block to the right, to make room for the AWGN Channel block.

- 2 Click the AWGN block and drag it onto the line. This automatically connects the Sine Wave block and the Vector Scope block to the AWGN Channel block.

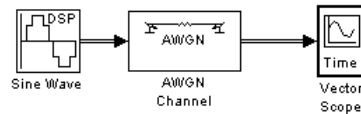

Sine Wave Plus Noise

Double-click the AWGN Channel block to open its dialog box, as shown in the following figure. Click the down arrow in the **Mode** field and select **Signal to noise ratio (SNR)**.

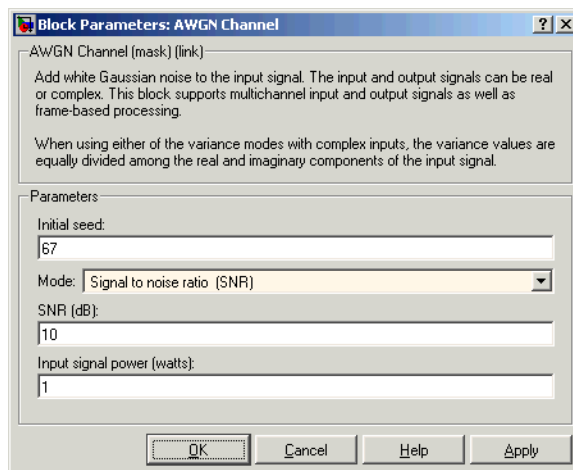

Dialog for the AWGN Channel Block

Now when you run the model, the scope clearly shows the added noise.

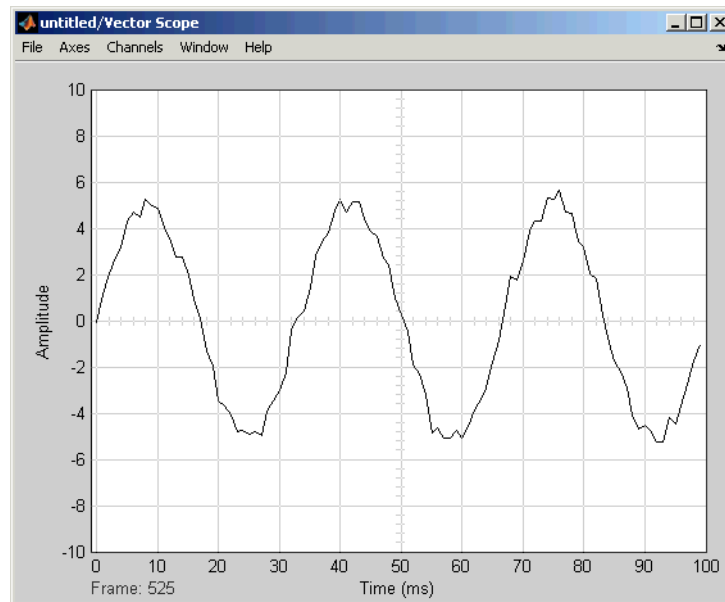

Sine Wave with Noise Added

When you are finished observing the simulation, stop the model by selecting **Simulation > Stop**.

Saving a Model

To save your model for future use, select **File > Save**. The first time you save the model, this displays the Save As dialog box. In the **Save in** field, select the folder where you want to save the model. It is best to keep your work files in a separate folder from the files shipped with the product. In the **File name** field, enter a name for the model, such as `sine.mdl`, and click **Save**.

To load the model in a future MATLAB session, first change your working folder to the one where you saved the file. You can do this by selecting the folder in the **Current Folder** field on the MATLAB toolbar. Then enter `sine` in the MATLAB Command Window.

Frames and Frame-Based Processing

A *frame* is a sequence of samples combined into a single vector. By setting **Samples per frame** to 100 in the Sine Wave block, you set the frame size to 100, so that each frame contains 100 samples. This enables the Vector Scope block to display enough data for a good picture of the sine wave.

Another important reason to set the frame size is that many Communications Blockset blocks require their inputs to be vectors of specific sizes. If you connect a source block, such as the Sine Wave block, to one of these blocks, you can set the input size correctly by setting **Samples per frame** to the required value. The model described in “Reducing the Error Rate Using a Hamming Code” on page 2-30 shows how to do this.

In *frame-based processing*, all the samples in a frame are processed simultaneously. In *sample-based processing*, on the other hand, samples are processed one at a time. The advantage of frame-based processing is that it can greatly increase the speed of a simulation. If you see double lines between blocks, the model uses frame-based processing.

Discrete Signals and Sample Times

The Sine Wave block in Signal Processing Blockset software generates a *discrete* signal. This means that it updates the signal at integer multiples of a fixed time interval, called the *sample time*. You can set the length of this time interval in the **Sample time** parameter in the block’s dialog box. In the example described in “Building a Simple Model” on page 2-11, the **Sample time** has the default value of 1/1000. All Communications Blockset and Signal Processing Blockset sources generate discrete signals exclusively. These sources are primarily designed for modeling digital communication systems.

To learn more about sample times, see “Building a Frequency-Shift Keying Model” on page 2-47.

Continuous Signals

The Simulink libraries also contain blocks that generate *continuous* signals. This means that they update the signal at variable time intervals, whose length is determined by the numerical solver the simulation uses. For

example, the Sine Wave block in the Simulink Sources library can generate a continuous sine wave.

Note Many blocks in Communications Blockset software accept only discrete signals. To find out whether a block accepts continuous signals, consult the reference page for the block.

Building a Channel Noise Model

In this section...

“Section Overview” on page 2-24

“Overview of the Model” on page 2-24

“Selecting Blocks for the Channel Noise Model” on page 2-25

“Setting Parameters in the Channel Noise Model” on page 2-26

“Connecting the Blocks” on page 2-27

“Running the Channel Noise Model” on page 2-28

Section Overview

This section shows how to build a simple model of a communication system. The model, shown in the following figure, contains the most basic elements of a communication system: a source for the signal, a channel with noise, and means of detecting errors caused by noise.

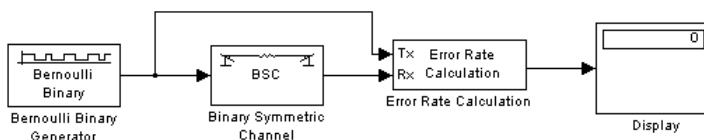

Channel Noise Model

You are encouraged to build the model for yourself, as this is the best way to learn how to use Communications Blockset software.

Overview of the Model

The channel noise model generates a random binary signal, and then switches the symbols 0 and 1 in the signal, according to a specified error probability, to simulate a channel with noise. The model then calculates the error rate and displays the result. The model contains the following components.

Source

The source for the signal in this model is the Bernoulli Binary Generator block, which generates a random binary sequence.

Channel

The Binary Symmetric Channel block simulates a channel with noise. The block introduces random errors to the signal by changing a 0 to a 1 or the reverse, with a probability specified by the **Error probability** parameter in the block's dialog.

Error Rate Calculation

The Error Rate Calculation block calculates the error rate of the channel. The block has two input ports, labeled Tx, for the transmitted signal, and Rx, for the received signal. The block compares the two signals and checks for errors. The output of the block is a vector with three entries:

- Bit error rate, which you expect to be approximately .01, because this is the probability of error in the channel
- Number of errors
- Total number of bits that are transmitted

Display

The Display block displays the output of the Error Rate Calculation block, as described in “Displaying the Error Rate” on page 2-6.

Selecting Blocks for the Channel Noise Model

To build the model, first move its blocks into a new model window, as follows:

- 1** Type `commstartup` at the MATLAB prompt to set simulation parameters for the model.
- 2** Type `simulink` at the MATLAB prompt to open the Simulink Library Browser.
- 3** From the menu, select **File > New > Model** to open a new model window.

4 Drag the following blocks from the Simulink Library Browser into the model window:

- Bernoulli Binary Generator block, from the Random Data Sources sublibrary of the Comm Sources library
- Binary Symmetric Channel block, from the Channels library
- Error Rate Calculation block, from the Comm Sinks library
- Display block, from the Simulink Sinks library

Setting Parameters in the Channel Noise Model

To set block parameters in the channel noise model, do the following:

1 Double-click the Binary Symmetric Channel block and make the following changes to the default parameters in the block's dialog:

- Set **Error probability** to 0.01.
- Clear the **Output error vector** check box. This removes the block's lower output port, which is not needed for this model.

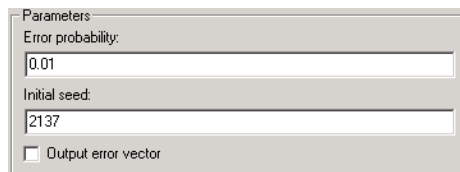

2 Double-click the Error Rate Calculation block and make the following changes to the default parameters in the block's dialog:

- Set **Output data** to Port to create an output port for the block.
- Select **Stop simulation**.

Parameters:

Receive delay:
0

Computation delay:
0

Computation mode: Entire frame

Output data: Port

Reset port

Stop simulation

Target number of errors:
100

Maximum number of symbols:
1e6

Selecting **Stop simulation** causes the simulation to stop after the target number of errors occurs or the maximum number of symbols is reached.

Initial Seeds

The Bernoulli Binary Generator block and the Binary Symmetric Channel block both use a random number generator to generate random sequences of bits. In both blocks, the **Initial seed** parameter initializes the random sequence. The initial seeds in the two blocks should have different values to ensure that the source signal and the channel noise are statistically independent. In general, initial seeds should have different values in all blocks that have an **Initial seed** parameter.

Connecting the Blocks

Next, connect the blocks as shown in the following figure. Make sure to connect the arrow from the Binary Symmetric Channel block to the input port labeled Rx on the Error Rate Calculation block. To learn how to do this, see “Connecting Blocks” on page 2-15.

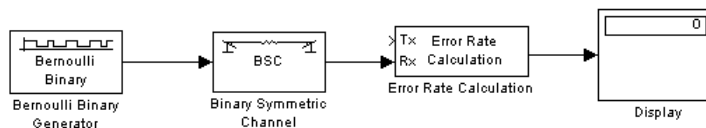

The next section explains how to draw the upper branch line in the model.

Drawing a Branch Line

The upper line leading from the Bernoulli Binary Generator block to the Error Rate Calculation block, shown in the following figure, is called a *branch line*. Branch lines carry the same signal to more than one block.

To draw the branch line, follow these steps:

- 1 Right-click the line between the Bernoulli Random Generator block and the Binary Symmetric Channel block.
- 2 While holding down the right mouse button, move the mouse pointer to the input port labeled Tx on the Error Rate Calculation block.
- 3 Release the mouse button. The end of the branch line should connect to the input port of the Error Rate Calculation block.
- 4 Click the horizontal section of the branch line and drag it upward until the line is above the Binary Symmetric Channel block.

The model should now appear as in the following figure.

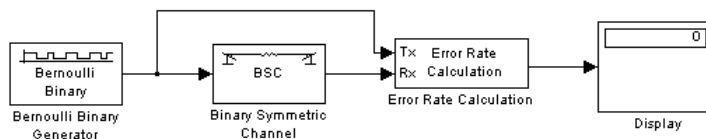

Running the Channel Noise Model

To run the model, select **Simulation > Start**. After a few seconds, the model stops automatically.

To see all three boxes in the Display block, you must enlarge the block slightly, as follows:

- 1 Select the Display block and move the mouse pointer to one of the lower corners of the block, so that a diagonal arrow appears on the corner, as shown.



- 2 Drag the corner of the block down with the mouse until three windows appear, as shown.

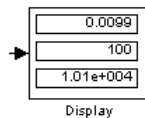

The Display block displays the following information:

- Bit error rate
- Number of errors
- Total number of bits that are transmitted

The exact values that appear will vary, depending on the **Initial seed** parameters in the Bernoulli Binary Generator block and the Binary Symmetric Channel block.

Because the **Target number of errors** in the dialog box for the Error Rate Calculation block is set to 100, the simulation stops when 100 errors have been detected.

To save the model, select **File > Save**, type a name for the model, such as channelnoise, in the **File name** field, and click **Save**.

Reducing the Error Rate Using a Hamming Code

In this section...

“Section Overview” on page 2-30

“Building the Hamming Code Model” on page 2-31

“Using the Hamming Encoder and Decoder Blocks” on page 2-32

“Setting Parameters in the Hamming Code Model” on page 2-32

“Labeling the Display Block” on page 2-33

“Running the Hamming Code Model” on page 2-33

“Displaying Frame Sizes” on page 2-34

“Adding a Scope to the Model” on page 2-34

“Setting Parameters in the Expanded Model” on page 2-35

“Observing Channel Errors with the Scope” on page 2-37

Section Overview

This section describes how to reduce the error rate in the model shown in the figure Channel Noise Model on page 2-24 by adding an error-correcting code. The following figure shows an example that uses a Hamming code.

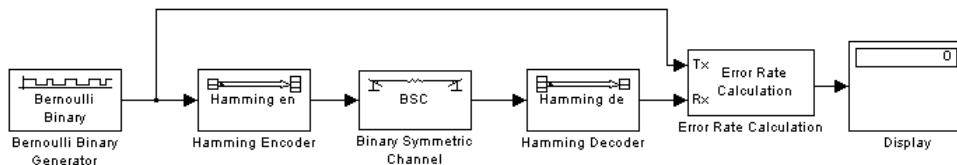

Hamming Code Model

You are encouraged to build the model for yourself. Alternatively, to open a completed version of the model, type `hammingdoc` at the MATLAB prompt.

Building the Hamming Code Model

You can build the Hamming code model by adding blocks to the model shown in the figure Channel Noise Model on page 2-24. To do so, follow these steps:

- 1 Type `channeldoc` at the MATLAB prompt to open the channel noise model. Then save the model as `my_hamming` in the folder where you keep your work files. See “Saving a Model” on page 2-21.
- 2 Drag the following two Communications Blockset blocks from the Simulink Library Browser into the model window:
 - Hamming Encoder block, from the Block sublibrary of the Error Detection and Correction library
 - Hamming Decoder block, from the Block sublibrary of the Error Detection and Correction library
- 3 Click the right border of the model and drag it to the right to widen the model window.
- 4 Move the Binary Symmetric Channel block, the Error Rate Calculation block, and the Display block to the right by clicking and dragging. This creates more space between the Binary Symmetric Channel block and the blocks next to it. The model should now look like the following figure.

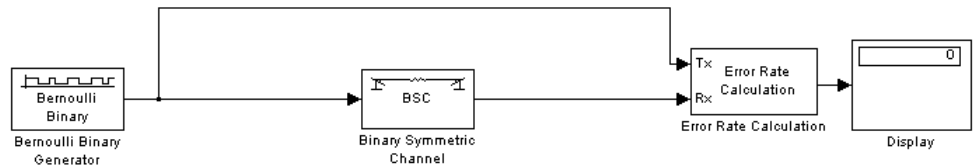

- 5 Click the Hamming Encoder block and drag it on top of the line between the Bernoulli Binary Generator block and the Binary Symmetric Channel block, to the right of the branch point, as shown in the following figure. Then release the mouse button. The Hamming Encoder block should automatically connect to the line from the Bernoulli Binary Generator block to the Binary Symmetric Channel block.

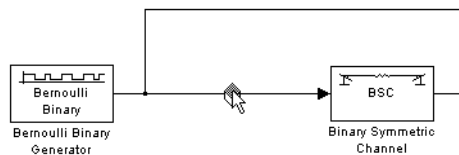

- 6 Click the Hamming Decoder block and drag it on top of the line between the Binary Symmetric Channel block and the Error Rate Calculation block.

Using the Hamming Encoder and Decoder Blocks

The Hamming Encoder block encodes the data before it is sent through the channel. The default code is the [7,4] Hamming code, which encodes message words of length 4 into codewords of length 7. As a result, the block converts frames of size 4 into frames of size 7. The code can correct one error in each transmitted codeword.

For an $[n,k]$ code, the input to the Hamming Encoder block must consist of vectors of size k . In this example, $k = 4$.

The Hamming Decoder block decodes the data after it is sent through the channel. If at most one error is created in a codeword by the channel, the block decodes the word correctly. However, if more than one error occurs, the Hamming Decoder block might decode incorrectly.

To learn more about the Communications Blockset block coding features, see “Block Coding” in the online documentation for Communications Blockset.

Setting Parameters in the Hamming Code Model

Double-click the Bernoulli Binary Generator block and make the following changes to the parameter settings in the block’s dialog box, as shown in the following figure:

- 1 Select the box next to **Frame-based outputs**.
- 2 Set **Samples per frame** to 4. This converts the output of the block into frames of size 4, in order to meet the input requirement of the Hamming Encoder Block. See “Frames and Frame-Based Processing” on page 2-22 for more information about frames.

Parameters

Probability of a zero:
0.5

Initial seed:
61

Sample time:
1

Frame-based outputs

Samples per frame:
4

Interpret vector parameters as 1-D

Note Many Communications Blockset blocks, such as the Hamming Encoder block, require their input to be a vector of a specific size. If you connect a source block, such as the Bernoulli Binary Generator block, to one of these blocks, select the box next to **Frame-based outputs** in the dialog for the source, and set **Samples per frame** to the required value.

Labeling the Display Block

You can change the label that appears below a block to make it more informative. For example, to change the label below the Display block to “Error Rate Display,” first select the label with the mouse. This causes a box to appear around the text. Enter the changes to the text in the box.

Running the Hamming Code Model

To run the model, select **Simulation > Start**. The model terminates after 100 errors occur. The error rate, displayed in the top window of the Display block, is approximately .001. You get slightly different results if you change the **Initial seed** parameters in the model or run a simulation for a different length of time.

You expect an error rate of approximately .001 for the following reason: The probability of two or more errors occurring in a codeword of length 7 is

$$1 - (0.99)^7 - 7(0.99)^6(0.01) = 0.002$$

If the codewords with two or more errors are decoded randomly, you expect about half the bits in the decoded message words to be incorrect. This indicates that .001 is a reasonable value for the bit error rate.

To obtain a lower error rate for the same probability of error, try using a Hamming code with larger parameters. To do this, change the parameters **Codeword length** and **Message length** in the Hamming Encoder and Decoder block dialog boxes. You also have to make the appropriate changes to the parameters of the Bernoulli Binary Generator block and the Binary Symmetric Channel block.

Displaying Frame Sizes

You can display the sizes of data frames in different parts of the model by selecting **Signal Dimensions** from the **Port/Signal Displays** submenu of the **Format** menu at the top of the model window. This is shown in the following figure. The line leading out of the Bernoulli Binary Generator block is labeled $[4 \times 1]$, indicating that its output consists of column vectors of size 4. Because the Hamming Encoder block uses a $[7,4]$ code, it converts frames of size 4 into frames of size 7, so its output is labeled $[7 \times 1]$.

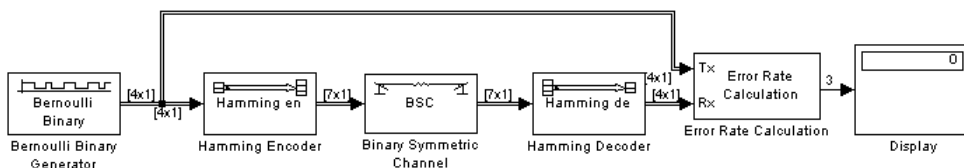

Displaying Frame Sizes

Adding a Scope to the Model

To display the channel errors produced by the Binary Symmetric Channel block, add a Scope block to the model. This is a good way to see whether your model is functioning correctly. The example shown in the following figure shows where to insert the Scope block into the model.

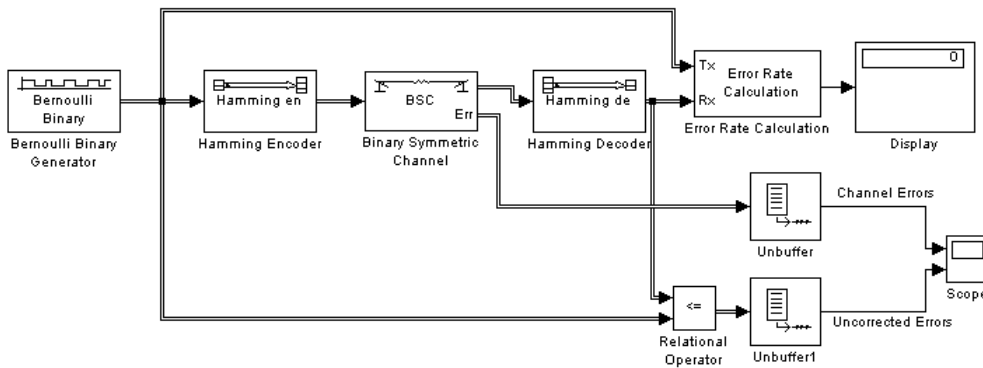

To build this model from the one shown in the figure Hamming Code Model on page 2-30, follow these steps:

- 1 Drag the following blocks from the Simulink Library Browser into the model window:
 - Relational Operator block, from the Simulink Logic and Bit Operations library
 - Scope block, from the Simulink Sinks library
 - Two copies of the Unbuffer block, from the Buffers sublibrary of the Signal Processing Blockset Signal Management library
- 2 Double-click the Binary Symmetric Channel block to open its dialog box, and select **Output error vector**. This creates a second output port for the block, which carries the error vector.
- 3 Double-click the Scope block and click the **Parameters** button  on the toolbar. Set **Number of axes** to 2 and click **OK**.
- 4 Connect the blocks as shown in the preceding figure. To learn how to do this, see “Connecting Blocks” on page 2-15 and “Drawing a Branch Line” on page 2-28.

Setting Parameters in the Expanded Model

Make the following changes to the parameters for the blocks you added to the model.

Error Rate Calculation Block

Double-click the Error Rate Calculation block and clear the box next to **Stop simulation** in the block's dialog box.

Scope Block

The Scope block displays the channel errors and uncorrected errors. To configure the block,

- 1 Double-click the block to open the scope, if it is not already open.
- 2 Click the **Parameters** button  on the toolbar.
- 3 Set **Time range** to 5000.
- 4 Click the **Data history** tab.
- 5 Type 30000 in the **Limit data points to last** field, and click **OK**.

The scope should now appear as shown.

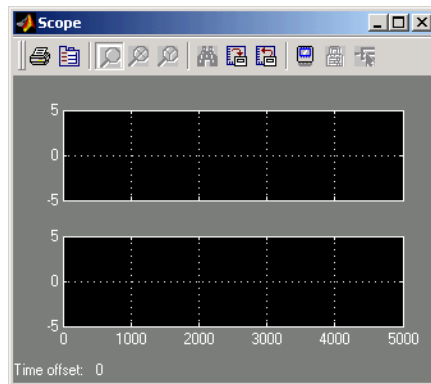

To configure the axes, follow these steps:

- 1 Right-click the vertical axis at the left side of the upper scope.
- 2 In the context menu, select **Axes properties**.
- 3 In the **Y-min** field, type -1.

- 4 In the **Y-max** field, type 2, and click **OK**.
- 5 Repeat the same steps for the vertical axis of the lower scope.
- 6 Widen the scope window until it is roughly three times as wide as it is high. You can do this by clicking the right border of the window and dragging the border to the right, while pressing the mouse button.

Relational Operator

Set **Relational Operator** to `~=` in the block's dialog box. The Relational Operator block compares the transmitted signal, coming from the Bernoulli Random Generator block, with the received signal, coming from the Hamming Decoder block. The block outputs a 0 when the two signals agree and a 1 when they disagree.

Observing Channel Errors with the Scope

When you run the model, the Scope block displays the error data. At the end of each 5000 time steps, the scope appears as shown in the following figure. The scope then clears the displayed data and displays the next 5000 data points.

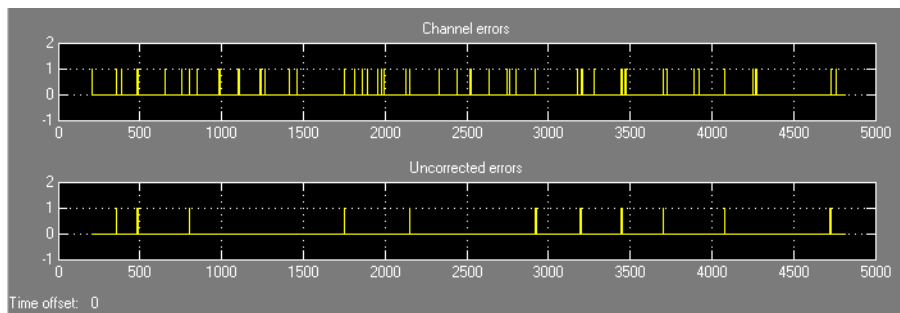

Scope with Model Running

The upper scope shows the channel errors generated by the Binary Symmetric Channel block. The lower scope shows errors that are not corrected by channel coding.

Click the **Stop** button on the toolbar at the top of the model window to stop the scope.

To zoom in on the scope so that you can see individual errors, first click the middle magnifying glass button at the top left of the Scope window. Then click one of the lines in the lower scope. This zooms in horizontally on the line. Continue clicking the lines in the lower scope until the horizontal scale is fine enough to detect individual errors. A typical example of what you might see is shown in the figure below.

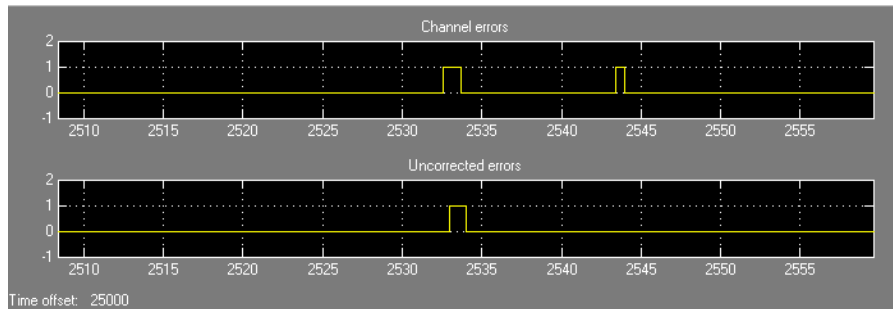

Zooming In on the Scope

The wider rectangular pulse in the middle of the upper scope represents two 1s. These two errors, which occur in a single codeword, are not corrected. This accounts for the uncorrected errors in the lower scope. The narrower rectangular pulse to the right of the upper scope represents a single error, which is corrected.

When you are done observing the errors, select **Simulation > Stop**.

“Sending Signal and Error Data to the Workspace” on page 3-4 explains how to send the error data to the MATLAB workspace for more detailed analysis.

Modeling a Channel with Modulation

In this section...

“Section Overview” on page 2-39

“Building the BPSK Model” on page 2-39

“Setting Parameters in the BPSK Model” on page 2-41

“Running the BPSK Model” on page 2-41

Section Overview

The Binary Symmetric Channel block, which simulates a channel with noise, is useful for building models of channel coding. For other types of applications, you might want to construct a more realistic model of a channel. For example, you can add modulation and demodulation, and replace the Binary Symmetric Channel block with an AWGN Channel block, which adds white Gaussian noise to the channel. The following figure shows an example that uses binary phase shift keying (BPSK).

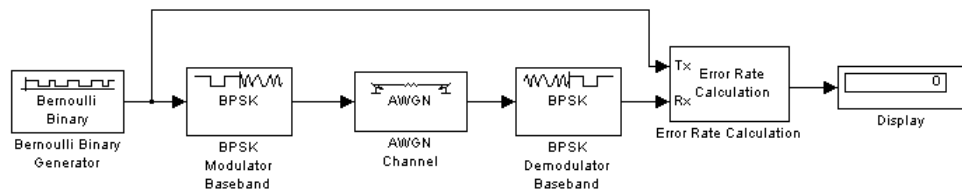

BPSK Modulation Model

You are encouraged to build the model for yourself. Alternatively, to open a completed version of the model, type `bpskdoc` at the MATLAB prompt.

Building the BPSK Model

You can build the BPSK model from the one shown in the figure Channel Noise Model on page 2-24. To build the model, follow these steps:

- 1 Enter `channeldoc` at the MATLAB prompt to open the channel noise model, and then save the model as `my_bpsk` in the folder where you keep your work files.

- 2 Delete the Binary Symmetric Channel block from the model by right-clicking the block and selecting **Clear**.
- 3 Move the following blocks from the Simulink Library Browser into the model window, and insert them into the model as shown in the following figure:
 - BPSK Modulator Baseband block, from PM in the Digital Baseband Modulation sublibrary of the Modulation library
 - AWGN Channel block, from the Channels library
 - BPSK Demodulator Baseband block, from PM in the Digital Baseband Modulation sublibrary of the Modulation library

The model should now appear as in the figure below.

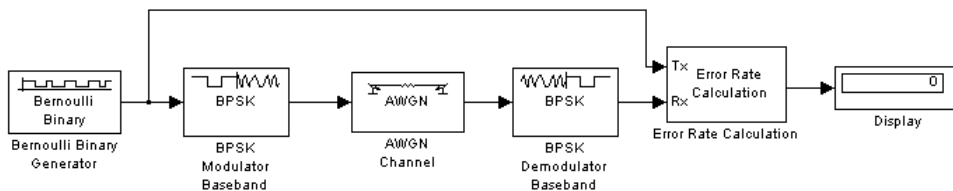

Binary Phase Shift Keying

The BPSK Modulator and Demodulator Baseband blocks implement binary phase shift keying (BPSK) modulation. BPSK is a method for modulating a binary signal onto a complex waveform by shifting the phase of the complex signal. In digital baseband BPSK, the symbols 0 and 1 are modulated to the complex numbers $\exp(jt)$ and $-\exp(jt)$, respectively, where t is a fixed angle. In this example, $t = 0$, so these numbers are just 1 and -1.

You can set the value of t in the **Phase offset** parameter in the dialog boxes for the BPSK Modulator Baseband block and the BPSK Demodulator Baseband block. The default value is 0.

To learn more about the Communications Blockset digital modulation features, see “Digital Modulation” in the online Communications Blockset documentation.

Setting Parameters in the BPSK Model

To set block parameters in the BPSK model, do the following:

- 1 Double-click the AWGN Channel block and set **Es/No** to 4.2.
- 2 Double-click the Error Rate Calculation block and make the following changes to the default parameters in the block's dialog:
 - Set **Output data** to Port.
 - Select the box next to **Stop simulation**.

Running the BPSK Model

When you run the model, the Display block shows an error rate of approximately 0.01, the same as in the channel noise model. The BPSK model uses the BPSK Modulator Baseband, the AWGN Channel, and the BPSK Demodulator Baseband blocks to simulate a channel with noise. This provides a more realistic model of a channel than using just the Binary Symmetric Channel block. You can also model other types of channel noise using blocks from the Communications Blockset Channels library.

Reducing the Error Rate with a Cyclic Code

In this section...

“Section Overview” on page 2-42

“Building the Cyclic Code Model” on page 2-42

“Running the Cyclic Code Model” on page 2-44

“Verifying the Symbol Period” on page 2-44

“Using a Probe Block to Determine Symbol Period” on page 2-45

Section Overview

You can improve the error rate in the model shown in the figure BPSK Modulation Model on page 2-39, for certain noise levels, by adding channel coding. An example that uses a binary cyclic code is shown below.

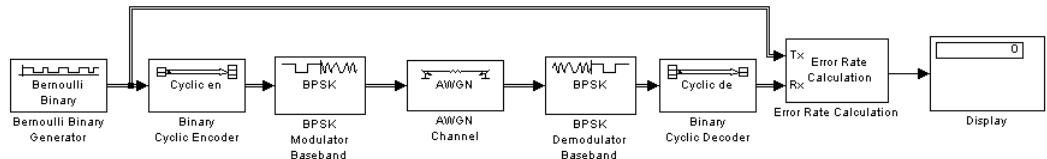

Building the Cyclic Code Model

You can build the cyclic code model by adding blocks to the BPSK model shown in the figure BPSK Modulation Model on page 2-39. To build the model, follow these steps:

- 1 Open the BPSK model by entering `bpskdoc` at the MATLAB prompt. Save the model as `my_cyclic` in the folder where you keep your work files.
- 2 Double-click the AWGN Channel block and set E_s/N_0 to 7. This value is chosen for this example to illustrate the benefit of using a code. If E_s/N_0 is much lower than the value chosen here, then the E_s/N_0 reduction caused by the additional coded bits will be greater than the coding gain provided by the code.

- 3 Run the simulation and note its error rate (for later comparison in “Running the Cyclic Code Model” on page 2-44). The error rate appears in the top entry of the Display block.
- 4 To introduce cyclic coding, drag these Communications Blockset blocks from the Simulink Library Browser into the model window:
 - Binary Cyclic Encoder block, from the Block sublibrary of the Error Detection and Correction library
 - Binary Cyclic Decoder block, from the Block sublibrary of the Error Detection and Correction library
- 5 Widen the model window and connect the blocks as below.

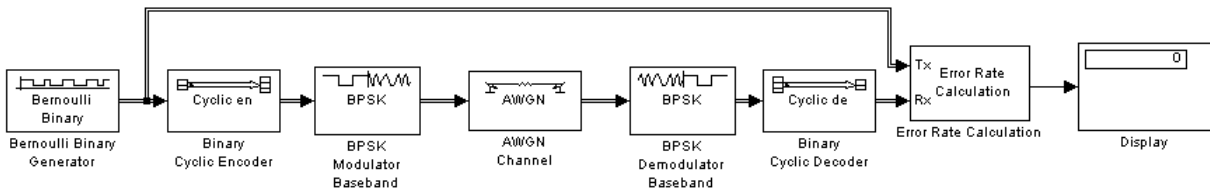

- 6 Double-click the Bernoulli Binary Generator block and change these parameters:
 - Select **Frame-based outputs**.
 - Set **Samples per frame** to 21 to match the input requirement of the Binary Cyclic Encoder block.
- 7 Double-click the Binary Cyclic Encoder block and change these parameters:
 - Set **Codeword length N** to 31.
 - Set **Message length K** to 21.

Make the same changes in the Binary Cyclic Decoder block.

- 8 Double-click the AWGN Channel block and change these parameters:
 - Set **Es/No** to $7 + 10 \cdot \log_{10}(21/31)$. The second term in this sum accounts for the difference in symbol period compared to the original BPSK model.
 - Set **Symbol period** to $21/31$. For more information on setting **Symbol period**, see “Verifying the Symbol Period” on page 2-44.

With these parameter values, the AWGN channel block produces the same amount of noise per symbol as in the BPSK model (without coding) in which E_s/N_0 is 7. The equivalence of the noise enables you to determine how much the cyclic code improves the bit error rate.

- 9 Double-click the Error Rate Calculation block and change this parameter:
 - Set **Maximum number of symbols** to 1e7. This extends the simulation, producing a more reliable estimate for the error rate.

Binary Cyclic Encoder and Decoder

The Binary Cyclic Encoder block implements a binary cyclic code. In this example, the block has the following parameter settings:

- **Codeword length N** = 31
- **Message length K** = 21

The code rate is given by

$$\text{Code rate} = \frac{\text{Message length}}{\text{Codeword length}}$$

This example uses a rate 21/31 code. The codeword length N must have the form $2^M - 1$, where M is an integer greater than or equal to 3. The input to the block must be a vector whose length is **Message length**.

The Binary Cyclic Decoder block decodes the demodulated signal. This block must have the same parameter settings as the Binary Cyclic Encoder block.

Running the Cyclic Code Model

When you run the simulation, the bit error rate is less than one-tenth of the error rate in the model that does not have channel coding.

Verifying the Symbol Period

When you compare the cyclic code model to the BPSK model, which does not have channel coding, the ratio of energy per information symbol to noise spectral density, E_b/N_0 , should be the same in both models. You can use the

Symbol period and **Es/No** parameters in the AWGN Channel block to adjust the amount of channel noise so that E_b/N_0 is the same as in the model without coding. Because the cyclic code has rate 21/31, set **Symbol period** to 21/31. For a BPSK simulation with a rate K/N code, set **Symbol period** to K/N because there are K information symbols for each N channel symbols.

Note that **Es/No**, the ratio of energy per channel symbol to noise spectral density, is not the same as E_b/N_0 . To convert between the two, use the formula

$$E_b / N_0 = E_s / N_0 - 10 \log(K / N)$$

where K/N is the ratio of information symbols to channel symbols. Changing the **Symbol period** to K/N has the same effect as subtracting $10 \cdot \log_{10}(K/N)$ from the **Es/No** parameter.

Using a Probe Block to Determine Symbol Period

If you are unsure how to set the **Symbol period**, you can find the correct value using a Probe block. To do so, follow these steps:

- 1** Drag these blocks from the Simulink Library Browser into the cyclic code model window:
 - Probe block, from the Simulink Signal Attributes library
 - Two copies of the Terminator block, from the Simulink Sinks library
- 2** Double-click the Probe block and change these parameters:
 - Clear the boxes next to **Probe complex signal** and **Probe signal dimensions**.
 - Select the boxes next to **Probe width** and **Probe sample time**. The block now has two output ports.
- 3** Connect the blocks as shown in the next figure.
- 4** Select **Edit > Update diagram**. Simulink updates the display on the Probe block, as in the next figure.

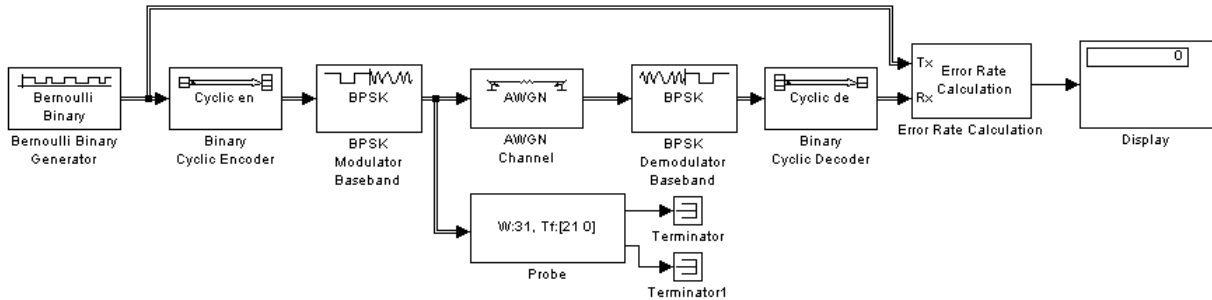

The number after W in the Probe block tells you the frame size, which in this case is 31. The first number after Tf tells you the frame period, which is 21. You can determine the symbol period using the following formula.

$$\text{Symbol period} = \frac{\text{Frame period}}{\text{Frame size}}$$

In this example, the symbol period is 21/31.

Building a Frequency-Shift Keying Model

In this section...

- “Section Overview” on page 2-47
- “Building the FSK Model” on page 2-48
- “Setting Parameters in the FSK Model” on page 2-49
- “Running the FSK Model” on page 2-50
- “Learning About Delays in the Model” on page 2-51
- “Finding the Delay in a Model” on page 2-51
- “Learning About Multirate Models” on page 2-52
- “Using Sample Time Colors to Check Sample Times” on page 2-53

Section Overview

Frequency-shift keying (FSK) is a standard modulation technique in which a digital signal is modulated onto a sinusoidal carrier whose frequency shifts between different values. The Bell Telephone System first used this technique in their Model 103 modem. The model shown in the following figure is an example of the baseband representation of FSK.

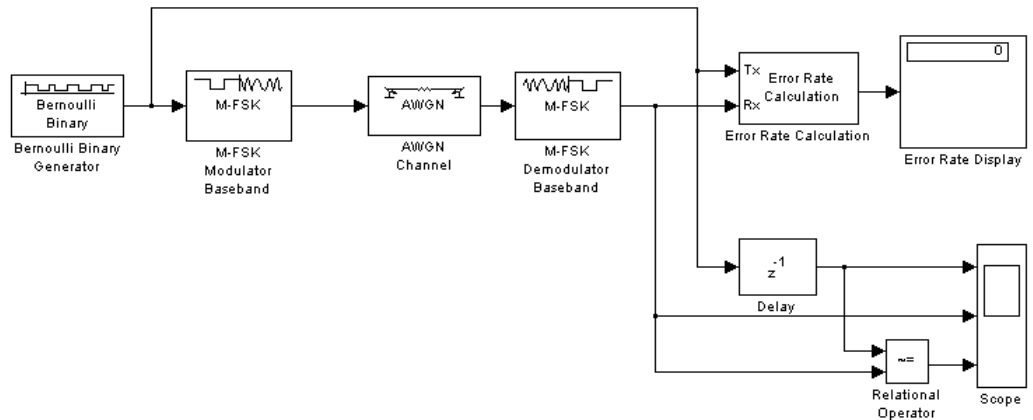

FSK Model

To open a completed version of the model, type `fskdoc` at the MATLAB prompt.

Building the FSK Model

You can build the FSK model by adding blocks to the model shown in the figure Channel Noise Model on page 2-24. To open the channel noise model, enter `channeldoc` at the MATLAB prompt. Then save the model as `my_fsk` in the folder where you keep your work files. See “Saving a Model” on page 2-21.

You need to add the following blocks to the model:

M-FSK Modulator and Demodulator Baseband

The M-FSK Modulator Baseband block, from FM in the Digital Baseband sublibrary of the Modulation library, modulates the binary signal using a baseband representation of FSK modulation.

The M-FSK Demodulator Baseband block, from FM in the Digital Baseband sublibrary of the Modulation library, demodulates the baseband signal.

AWGN Channel

The AWGN Channel block, from the Channels library, models a channel using additive white Gaussian noise. In this model, AWGN is more suitable than a binary symmetric channel.

Relational Operator

The Relational Operator block, from the Simulink Logic and Bit Operations library, compares the transmitted signal, from the Bernoulli Binary Generator block, with the received signal, from the M-FSK Demodulator Baseband block. The block outputs a 0 when the two signals agree, and a 1 when they differ.

Scope

The Scope block, from the Simulink Sinks library, displays the transmitted signal, the received signal, and the output of the Relational Operator block. To create three input ports for the block, follow these steps:

- 1 Double-click the block to open the scope.

- 2** Click the **Parameters** button  on the toolbar.
- 3** Set **Number of axes** to 3.
- 4** Set **Time range** to 1 and click **OK**.

To set the limits on the vertical axes,

- 1** Right-click the vertical axis at the left side of the upper scope.
- 2** In the context menu, select **Axes properties**.
- 3** In the **Y-min** field, type -1.
- 4** In the **Y-max** field, type 2, and click **OK**.

Repeat these steps for the middle and lower vertical axes.

Delay

The Delay block, from the Signal Processing Blockset Signal Operations library, delays the transmitted signal so that it can be accurately compared with the received signal. Its purpose is explained further in “Learning About Delays in the Model” on page 2-51.

Drag these blocks into the model window and connect them as shown in the figure FSK Model on page 2-47. Remove the Binary Symmetric Channel block because it is no longer needed. The next section explains how to set the parameters for these blocks.

Setting Parameters in the FSK Model

Make the following changes to the default parameter settings in the dialog boxes for the blocks:

- 1** Double-click the Bernoulli Binary Generator block and make the following changes to the default parameters in the block’s dialog box:
 - Set **Probability of a zero** to 0.5.
 - Set **Sample time** to 1/1200.

- 2 Double-click the M-FSK Modulator Baseband block and make the following changes to the default parameters in the block's dialog box:
 - Set **M-ary number** to 2. This specifies the number of frequencies in the modulated signal.
 - Set **Frequency separation** to 1000. This specifies the separation between the two frequencies of the modulated signal.
 - Set **Samples per symbol** to 5. This causes the block to oversample the incoming signal. Oversampling increases the sampling rate by a factor of 5.
- 3 Double-click the M-FSK Demodulator Baseband block and make the same changes to the block's default parameters as for the M-FSK Modulator Baseband block.
- 4 Double-click the AWGN Channel block and set **Symbol period** to 1 / 1200.
- 5 Double-click the Error Rate Calculation block and make the following changes to the default parameters in the block's dialog box:
 - Set **Receive delay** to 1.
 - Set **Output data** to Port.

Running the FSK Model

Set the **Stop time** parameter to 15 and run the model.

Displaying the Errors in the Scope

Double-click the Scope block to open the scope.

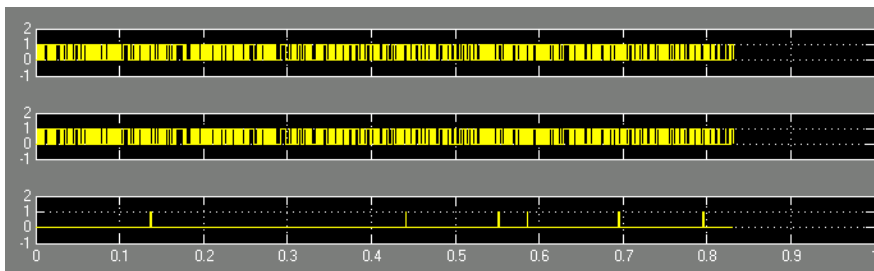

The top window displays the transmitted signal. The middle window displays the received signal. The bottom window displays a 0 where the two signals agree and a 1 where they differ.

Learning About Delays in the Model

Some blocks cause a signal to be delayed as it passes through a model, because of the way they process data. For example, there is a delay of one symbol period between the input signal to the M-FSK Modulator Baseband block and the output signal from the M-FSK Demodulator Baseband block. As a result, there is a delay of 1 between the transmitted and received signals in the model. “Finding the Delay in a Model” on page 2-51 shows how to find the value of this delay.

To compare these two signals and calculate the bit error rate correctly, you need to delay the transmitted signal by 1 to synchronize it with the received signal. This is why you set the **Receive delay** to 1 in the dialog box for the Error Rate Calculation block, and left the **Delay** at its default value of 1 in the Delay block.

Note If the Error Rate Calculation block in a model gives an error rate close to .5 for a random binary signal, you might not have taken into account delays in the model. The block is probably comparing two unsynchronized signals.

Several blocks in the Communications Blockset Modulation library produce delays. A list of these is given in “Delays in Digital Modulation” in the online Communications Blockset documentation. The Viterbi Decoder block, from the Convolutional sublibrary of the Error Detection and Correction library, also produces a delay equal to its **Traceback depth** parameter; see the section “Viterbi Decoder” on page 2-56.

Finding the Delay in a Model

To find the delay between the transmitted and received signals in a model, you can use a Find Delay block. To do so, insert the following blocks into the FSK model:

- Find Delay, from the Utility Blocks library

- Display, from the Simulink Sinks library

Connect the blocks as shown at the top right of the following figure.

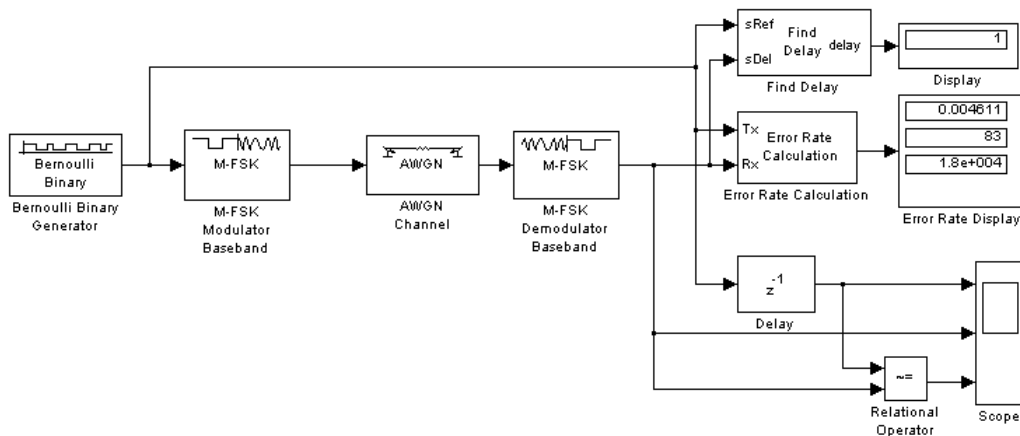

When you run the simulation, the Display block labeled Display shows that the delay is 1. You can use this information to set the **Receive delay** parameter in the Error Rate Calculation block and the **Delay** parameter in the Delay block.

Learning About Multirate Models

The model shown in the figure FSK Model on page 2-47 differs from the earlier models in that it contains signals with different sample times. The Bernoulli Binary Generator block has a sample time of 1/1200. The M-FSK Modulator Baseband block receives this signal and upsamples it at a rate of five samples per symbol. As a result, the sample time of the block’s output signal is 1/6000. A model that contains signals with different sample times is called a *multirate* model.

The multiple sample times present in this model do not affect the bit error rate of a simulation. But be aware that in other models, sample times can affect the results of a simulation. This is usually the case when different signals are combined. See “Setting Sample Times and Samples per Frame” on page 3-16 for an example of this.

Using Sample Time Colors to Check Sample Times

You can easily check whether there are different sample times in a model by selecting: **Format > Sample Time Display**. Next, select **Edit > Update Diagram**. When you do this, blocks and lines in the model are colored according to their sample times.

Red blocks and lines indicate the fastest sample time in the model. Green indicates the second fastest sample time. Yellow blocks contain signals with different sample times. If all sample times in the model are the same, all blocks and lines are colored red. For more information on displaying sample time colors, see the Simulink documentation.

For frame-based signals, the colors correspond to the frame periods of the signals rather than sample times.

If you need to determine the actual sample time of a signal, you can use a Probe block as described in “Using a Probe Block to Determine Symbol Period” on page 2-45.

Building a Convolutional Code Model

In this section...

“Section Overview” on page 2-54

“Building the Convolutional Code Model” on page 2-54

“Understanding the Blocks in the Model” on page 2-55

“Setting Parameters in the Convolutional Code Model” on page 2-56

“Running the Convolutional Code Model” on page 2-57

Section Overview

The following model simulates the use of convolutional coding to send a signal through a channel with noise.

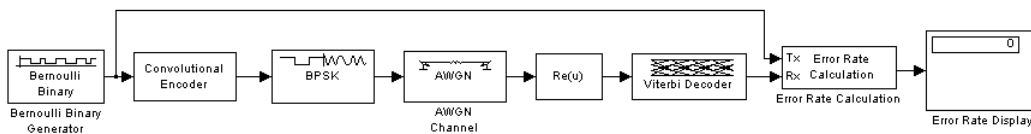

Convolutional Code Model

To open a completed version of the model, enter `convdoc` at the MATLAB prompt.

Building the Convolutional Code Model

You can build the convolutional code model by adding blocks to the model shown in the figure Channel Noise Model on page 2-24.

To build the model, follow these steps:

- 1 Enter `channeldoc` at the MATLAB Help browser to open the channel noise model. Then save the model as `my_conv` in the folder where you keep your work files.
- 2 Delete the Binary Symmetric Channel block.

3 Drag the following blocks from the Simulink Library Browser into the model window, and connect them as shown in the figure Convolutional Code Model on page 2-54:

- Convolutional Encoder, from the Convolutional sublibrary of the Error Detection and Correction library
- BPSK Modulator Baseband, from PM in the Digital Baseband Modulation sublibrary of the Modulation library
- Complex to Real-Imag, from the Simulink Math Operations library
- Viterbi Decoder, from the Convolutional sublibrary of the Error Detection and Correction library

Understanding the Blocks in the Model

This model contains the blocks discussed in the following subsections.

Convolutional Encoder

The Convolutional Encoder block encodes the signal from the Bernoulli Binary Generator. The example uses the industry standard rate 1/2 convolutional code, with constraint length 7, defined by the following diagram.

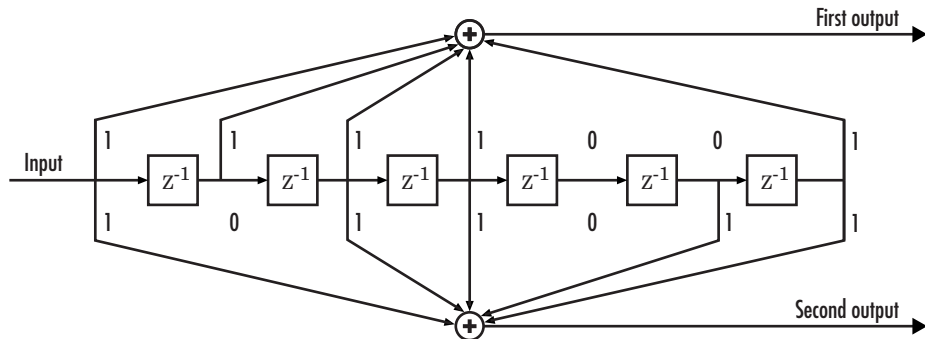

Convolutional Encoder Schematic Block Diagram

The encoder structure is described by a pair of binary numbers, having the same length as the code's constraint length, that specify the connections from the delay cells to modulo-2 addition nodes. The binary number for the upper addition node is 1111001. A 1 indicates that the bit in the corresponding delay cell (reading from left to right) is sent to the addition node, and a 0

indicates that the bit is not sent. The binary number for the lower addition node is 1011011. Converting these two binary numbers to octal gives the pair [171,133]. You can enter this pair into the block's dialog box by typing `poly2trellis(7, [171 133])` in the field for **Trellis Structure**.

To learn more about the Communications Blockset convolutional coding features, see “Convolutional Coding” in the online Communications Blockset documentation.

Complex to Real-Imag

The Complex to Real-Imag block, labeled Re(u), receives the complex signal and outputs its real part. Because the output BPSK Modulator Baseband block has zero complex part, all of the signal is carried by the real part. You can set this option by selecting **Real** in the **Output** parameter field in the block's dialog box. It is not necessary to demodulate the signal, because the Viterbi Decoder block can accept unquantized inputs.

Viterbi Decoder

The Viterbi Decoder block decodes the signal using the Viterbi algorithm. The **Decision Type** parameter is set to **Unquantized** so that the block can accept real numbers from the Complex to Real-Imag block. The **Traceback depth** parameter, which is set to **96**, is the number of branches in the trellis that the block uses to construct each traceback path. This produces a delay of **96** between the input and output of the block. For more information on delays, see “Finding the Delay in a Model” on page 2-51.

For an example of a convolutional coding model that uses soft-decision decoding, see “Example: Soft-Decision Decoding” in the online Communications Blockset documentation.

Setting Parameters in the Convolutional Code Model

To set parameters in the convolutional code model, do the following:

- 1** Double-click the Bernoulli Binary Generator block and select the box next to **Frame-based outputs** in the block's dialog box.
- 2** Double-click the AWGN Channel block and make the following changes to the default parameters in the block's dialog box:

- Set **Es/No** to -1.
 - Set **Symbol period** to 1/2. Because the code rate is 1/2, this setting causes the block to produce the same amount of noise per channel symbol as it would without channel coding. For more information, see “Verifying the Symbol Period” on page 2-44.
- 3** Double-click the Error Rate Calculation block and make the following changes to the default parameters in the block’s dialog box:
- Set **Receive delay** to 96. The Viterbi Decoder block creates a delay of 96, due to its **Traceback depth** setting.
 - Select the box next to **Stop simulation**.
 - Set **Target number of errors** to 100.

Running the Convolutional Code Model

When you run the model, you observe an error rate of approximately .003.

Using Communications Blockset Software with MATLAB

This chapter describes how to use MATLAB to extend the capabilities of Communications Blockset. The chapter explains how to run simulations from the command line, and how to run multiple simulations. It also explains how to transfer data between a model and the MATLAB workspace.

- “Sending Data to the MATLAB Workspace” on page 3-2
- “Running Simulations from the Command Line” on page 3-7
- “Importing Data from the MATLAB Workspace” on page 3-13
- “Learning More” on page 3-19

Sending Data to the MATLAB Workspace

In this section...
“Section Overview” on page 3-2
“Using a Signal To Workspace Block” on page 3-2
“Configuring the Signal To Workspace Block” on page 3-3
“Viewing the Error Rate Data in the Workspace” on page 3-3
“Sending Signal and Error Data to the Workspace” on page 3-4
“Viewing the Signal and Error Data in the Workspace” on page 3-5
“Analyzing Signal and Error Data” on page 3-6

Section Overview

This section explains how to send data from a Simulink model to the MATLAB workspace so you can analyze the results of simulations in greater detail.

Using a Signal To Workspace Block

You can use a Signal To Workspace block, from Signal Processing Sinks library of the Signal Processing Blockset application to send data to the MATLAB workspace as a vector. For example, you can send the error rate data from the Hamming code model, described in the section “Reducing the Error Rate Using a Hamming Code” on page 2-30. To insert a Signal to Workspace block into the model, follow these steps:

- 1** Type `hammingdoc` at the MATLAB Help browser to open the model.
- 2** Drag a Signal To Workspace block, from the Signal Processing Sinks library, into the model window and connect it as shown in the following figure.

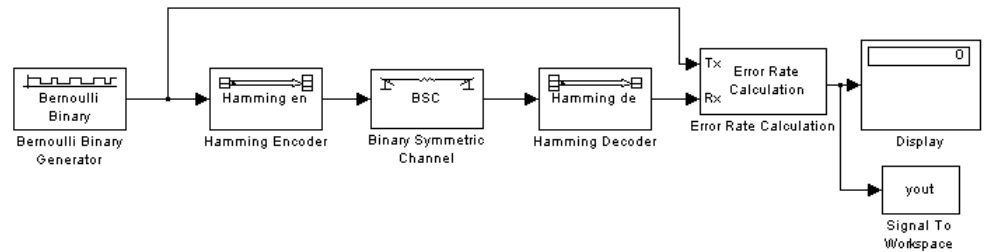

Hamming Code Model with a Signal To Workspace Block

Configuring the Signal To Workspace Block

To configure the Signal to Workspace block, follow these steps:

- 1 Double-click the block to display its dialog box.
- 2 Type `hammcode_BER` in the **Variable name** field.
- 3 Type `1` in the **Limit data points to last** field. This limits the output vector to the values at the final time step of the simulation.
- 4 Click **OK**.

When you run a simulation, the model sends the output of the Error Rate Calculation block to the workspace as a vector of size 3, called `hamming_BER`. The entries of this vector are the same as those shown by the Error Rate Display block.

Viewing the Error Rate Data in the Workspace

After running a simulation, you can view the output of the Signal to Workspace block by typing the following commands at the MATLAB prompt:

```
format short e
hammcode_BER
```

The vector output is the following:

```
hammcode_BER =
5.4066e-003  1.0000e+002  1.8496e+004
```

The command format `short e` displays the entries of the vector in exponential form. The entries are as follows:

- The first entry is the error rate.
- The second entry is the total number of errors.
- The third entry is the total number of comparisons made.

Sending Signal and Error Data to the Workspace

To analyze the error-correction performance of the Hamming code, send the transmitted signal, the received signal, and the error vectors, created by the Binary Symmetric Channel block, to the workspace. An example of this is shown in the following figure.

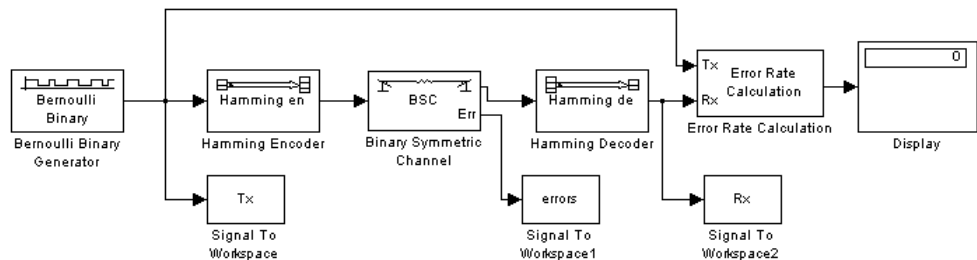

Sending Signal and Error Data to the Workspace

You can build this model from the one shown in the figure Hamming Code Model on page 2-30. To build the model, follow these steps:

- 1 Type `hammingdoc` to open the model.
- 2 Double-click the Binary Symmetric Channel block to open its dialog box, and select **Output error vector**. This creates an output port for the error data.
- 3 Drag three Signal To Workspace blocks, from the Signal Processing Sinks library, into the model window and connect them as shown in the preceding figure.
- 4 Double-click the left Signal To Workspace block.

- Type Tx in the **Variable name** field in the block's dialog box. The block sends the transmitted signal to the workspace as an array called Tx.
 - In the **Frames** field, select Log frames separately (3-D array). This preserves each frame as a separate column of the array Tx.
 - Click **OK**.
- 5** Double-click the middle Signal To Workspace block:
- Type errors in the **Variable name** field.
 - In the **Frames** field, select Log frames separately (3-D array).
 - Click **OK**.
- 6** Double-click the right Signal To Workspace block:
- Type Rx in the **Variable name** field.
 - In the **Frames** field, select Log frames separately (3-D array).
 - Click **OK**.

Viewing the Signal and Error Data in the Workspace

After running a simulation, you can display individual frames of data. For example, to display the tenth frame of Tx, at the MATLAB prompt type

```
Tx(:, :, 10)
```

This returns a column vector of length 4, corresponding to the length of a message word. Usually, you should not type Tx by itself, because this displays the entire transmitted signal, which is very large.

To display the corresponding frame of errors, type

```
errors(:, :, 10)
```

This returns a column vector of length 7, corresponding to the length of a codeword.

To display frames 1 through 5 of the transmitted signal, type

```
Tx(:, :, 1:5)
```

Analyzing Signal and Error Data

You can use MATLAB to analyze the data from a simulation. For example, to identify the differences between the transmitted and received signals, type

```
diffs = Tx~=Rx;
```

The vector `diffs` is the XOR of the vectors `Tx` and `Rx`. A 1 in `diffs` indicates that `Tx` and `Rx` differ at that position.

You can determine the indices of frames corresponding to message words that are incorrectly decoded with the following MATLAB command:

```
error_indices = find(diffs);
```

A 1 in the vector `not_equal` indicates that there is at least one difference between the corresponding frame of `Tx` and `Rx`. The vector `error_indices` records the indices where `Tx` and `Rx` differ. To view the first incorrectly decoded word, type

```
Tx(:, :, error_indices(1))
```

To view the corresponding frame of errors, type

```
errors(:, :, error_indices(1))
```

Analyze this data to determine the error patterns that lead to incorrect decoding.

Running Simulations from the Command Line

In this section...

“Section Overview” on page 3-7

“Running a Single Simulation” on page 3-7

“Running Multiple Simulations” on page 3-8

“Plotting the Results of Multiple Simulations” on page 3-10

“Running Multiple Simulations Using BERTool” on page 3-10

Section Overview

This section describes how to run simulations from the command line using the `sim` command. This is especially useful for running multiple simulations on a model.

Running a Single Simulation

As an example, to run the phase noise model, described in “Running a Simulink Model” on page 2-2, from the command line, enter

```
sim('commphasenoise')
```

in the MATLAB Command Window. This runs the model in the background without opening the model window. While the simulation is running, the MATLAB prompt is unavailable and you cannot enter another MATLAB command.

After the simulation stops, the prompt reappears. You can then view the results of the simulation by typing `commphasenoise` to open the model.

It is not necessary to open the model window when running a simulation from the command line. Usually you want to send the results of the simulation to the MATLAB workspace, for example, if you are running multiple simulations on a single model.

You can also specify simulation parameters from the command line. For example, the command

```
sim('commphasenoise', 1000);
```

runs the model with a **Stop time** of 1000. This overrides the **Stop time** setting in the Configuration Parameters dialog box. For more information on running simulations, see the Simulink documentation.

Running Multiple Simulations

You can run multiple simulations, with different parameters, from the command line using a MATLAB script. This section describes how to run the phase noise model with varying amounts of channel noise.

Preparing the Model

- 1 Type `commphasenoise` to open the model.
- 2 Drag a Signal To Workspace block, from the Signal Processing Sinks library, into the model window and connect it as shown in the following figure.

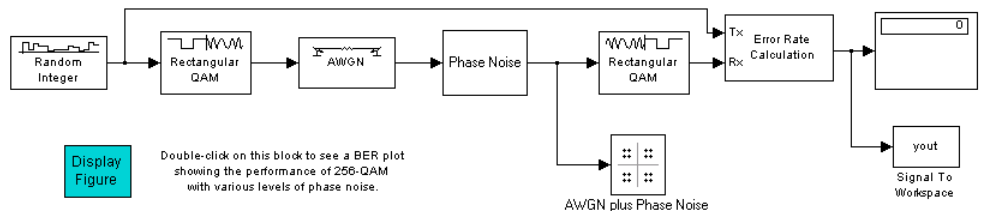

Phase Noise Model with a Signal To Workspace Block

- 3 Double-click the Signal To Workspace block and make these changes in the block's dialog box:
 - Set **Variable name** to `phase_err`.
 - Set **Limit data points to last** to 1.
- 4 Select **Simulation > Configuration parameters** and set **Stop time** to `inf`.

- 5** Enter the following commands in the MATLAB Command Window. This creates variables for the simulation's stopping criteria, as well as a vector of E_b/N_0 values.

```
maxNumErrs = 200;
maxNumBits = 10^5;
EbNoVec = 20:0.5:23;
```

- 6** Double-click the AWGN Channel block and set **Es/No** to $EbNo+10*\log_{10}(8)$ in the block's dialog box. The variable `EbNo` represents the bit energy to noise ratio. The term $10*\log_{10}(8)$ converts `EbNo` to **Es/No**, which is the symbol energy to noise ratio. The 8 appears because there are eight bits per channel symbol in 256-QAM.
- 7** Double-click the Error Rate Calculation block and make the following changes in the block's dialog box:
- Select **Stop simulation**.
 - Set **Target number of errors** to `maxNumErrs`.
 - Set **Maximum number of symbols** to `maxNumBits`.
- 8** Save the model in your working folder under a different file name, such as `my_commphasenoise`.

Running the Simulation Multiple Times

Now that the model and variables are set up, you can run multiple simulations, each with a different **Es/No** parameter. The following script runs the simulations in a loop and stores the results in a matrix called `SER_Vec`. The simulations might take several minutes to run.

```
SER_Vec=[];
for n = 1:length(EbNoVec);
    EbNo = EbNoVec(n);
    sim('my_commphasenoise');
    SER_Vec(n,:) = phase_err;
end;
```

When the simulations have ended and the prompt reappears, enter the following at the MATLAB prompt:

```
format short e  
SER_Vec
```

This displays the results in a matrix. Each row is the output of the Error Rate Calculation block for a single simulation. The first column, which gives the error rates for each simulation, decreases, because the noise level decreases as EbNo increases. The last column gives the number of symbols processed in each simulation.

Plotting the Results of Multiple Simulations

Plot the symbol error rates by entering the following commands.

```
semilogy(EbNoVec,SER_Vec(:,1),'*');  
xlabel('Eb/No (dB)');ylabel('SER');  
title('Phase Noise Performance of 256-QAM');  
legend('Phase noise level: -66 dBc/Hz');
```

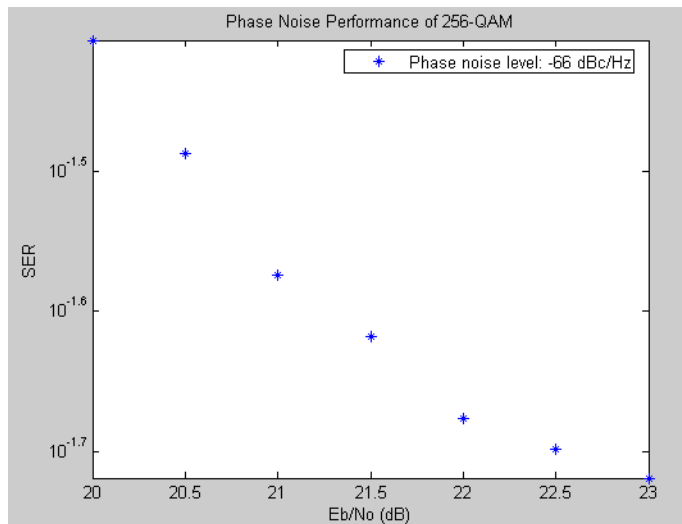

Running Multiple Simulations Using BERTool

The BERTool graphical user interface in Communications Toolbox can run multiple Simulink simulations and create a BER plot. This section describes

how to use BERTool with a modified `commphasenoise` model. For more general instructions on using BERTool, see the BERTool section of the Communications Toolbox documentation.

To create a BER plot for the phase noise model using BERTool, follow these steps:

- 1** Follow the procedure in “Preparing the Model” on page 3-8, if you have not already done so. `EbNo`, `maxNumErrs`, and `maxNumBits` are special variable names that BERTool recognizes.
- 2** Drag two Integer to Bit Converter blocks from the Utility Blocks library into the model. Insert them before the Error Rate Calculation block, as shown below. This causes the Error Rate Calculation block to compute a bit error rate instead of a symbol error rate. BERTool is designed to compute bit error rates.

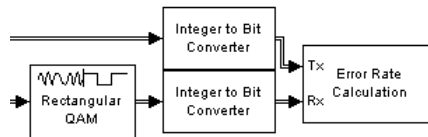

- 3** Double-click each of the Integer to Bit Converter blocks and set **Number of bits per integer** to 8 in the dialog boxes.
- 4** Save the model in your working folder as `my_commphasenoise_ber.mdl`.
- 5** Open the BERTool GUI by entering `bertool` in the MATLAB Command Window.
- 6** Click the **Monte Carlo** tab.
- 7** Make the following changes in the GUI:
 - Set **Eb/No range** to `EbNoVec`.
 - Set **Simulation M-file or model** to `my_commphasenoise_ber.mdl`.
 - Set **BER variable name** to `phase_err`.
 - Set **Number of errors** to 200.

- Set **Number of bits** to 10^5 .

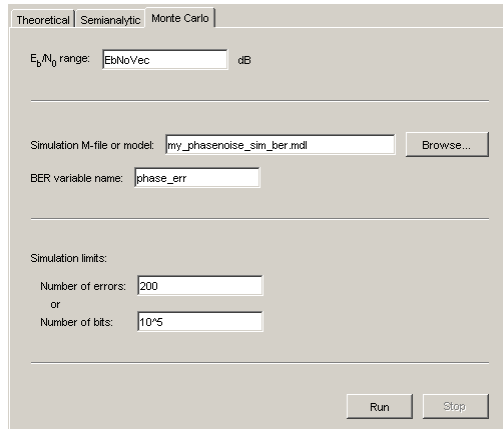

8 Click **Run**.

BERTool runs the simulation multiple times, gathers bit error rate results, and produces a plot like the following. (Although the shape resembles the plot shown in “Plotting the Results of Multiple Simulations” on page 3-10, the plot there shows symbol error rates while the plot here shows bit error rates.)

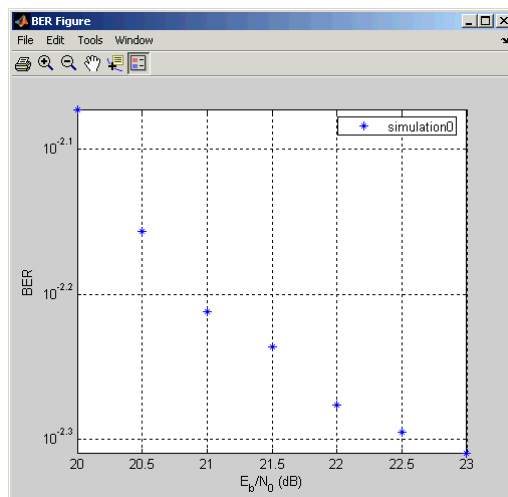

Importing Data from the MATLAB Workspace

In this section...

“Section Overview” on page 3-13

“Simulating a Signal by Importing Data” on page 3-13

“Simulating Noise with Imported Data” on page 3-14

“Simulating Noise with Specified Error Patterns” on page 3-15

“Setting Sample Times and Samples per Frame” on page 3-16

Section Overview

This section explains how to import data into a model directly from the MATLAB workspace using the Signal From Workspace block, from the Signal Processing Sources library. This enables you to run simulations on data that you create in the workspace or import from outside MATLAB. You can also create specific error patterns, such as burst errors, and import them into a model to test error correction codes.

Simulating a Signal by Importing Data

To import a signal that you create in the workspace, you can use a Signal From Workspace block as a source. An example is the model shown in the following figure. This model is the same as the one shown in the figure Channel Noise Model on page 2-24, except that the Bernoulli Binary Generator block has been replaced with a Signal From Workspace block.

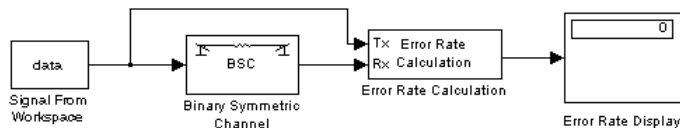

Importing a Signal from the Workspace

To build this model, follow these steps:

- 1 Enter `channeldoc` at the MATLAB prompt to open the channel noise model. Then save it under a different name in the directory where you keep your work files.
- 2 Replace the Bernoulli Binary Generator block with a Signal From Workspace block, from the Signal Processing Sources library.
- 3 In the Signal from Workspace block's dialog, change the **Signal** parameter to `data` (or another variable name).

Before using the model, define the vector `data` in the MATLAB workspace. For example, type `data=randint(1,10^4);` at the MATLAB prompt. This defines `data` as a random binary vector of length 10^4 .

Next, select **Simulation > Configuration Parameters** and set the **Stop time** parameter to `length(data)`. When you run a simulation, the model imports the random vector `data` into the model.

Change the vector `data` in the MATLAB workspace to simulate a less random signal, or import a signal from outside MATLAB.

Simulating Noise with Imported Data

You can also use the Signal From Workspace block to simulate channel noise with specific error patterns, in order to test the performance of an error correcting code. An example of this is shown in the following figure.

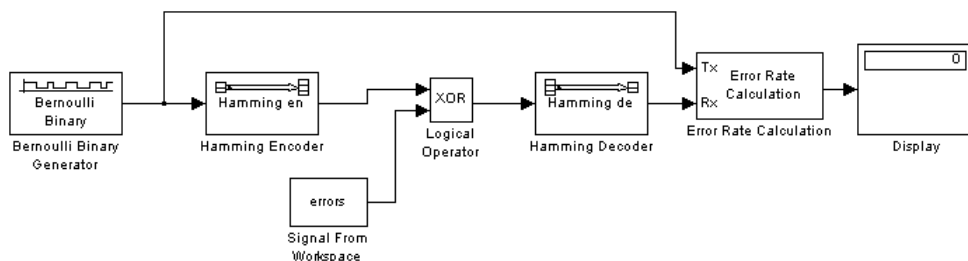

Using Data from the Workspace to Simulate Errors

This example is similar to the model shown in the figure Hamming Code Model on page 2-30, but instead of using the Binary Symmetric Channel block to simulate noise, the model imports error data from the workspace.

To build this model, follow these steps:

- 1** Type `hammingdoc` at the MATLAB prompt to open the Hamming code model. Then save the model under a different name in the folder where you store your work files.
- 2** Delete the Binary Symmetric Channel block from the model.
- 3** Drag the following blocks into the model window:
 - A Signal From Workspace block, from the Signal Processing Sources library
 - A Logical Operator block, from the Simulink Math Operations library
- 4** Connect these blocks as shown in the preceding figure.
- 5** Select **Simulation > Configuration Parameters** to open the Configuration Parameters dialog box.
- 6** Type `length(errors)` in the **Stop time** field and click **OK**.
- 7** Double-click the Signal From Workspace block and make the following changes to the default parameters in the block's dialog box:
 - Set **Signal** to `errors`.
 - Set **Sample time** to `4/7`.
 - Set **Samples per frame** to `7`, to match the frame size of the signal coming out of the Hamming Encoder block.
- 8** Double-click the Logical Operator block and set **Operator** to `XOR` in the block's dialog box.

Simulating Noise with Specified Error Patterns

To use the model in the figure Using Data from the Workspace to Simulate Errors on page 3-14, you must first create a binary vector called `errors` in the workspace to represent errors in the channel. A 1 in the vector represents

an error in the channel, while a 0 represents no error. When you run a simulation, the Logical Operator block performs the XOR operation on the vector errors and the signal.

For example, to create a vector of length 7×10^4 that contains exactly one 1 in each sequence of entries from $7n + 1$ to $7(n + 1)$, enter the following at the MATLAB prompt:

```
errors=[];  
for n=1:10^4  
    p=randperm(7);  
    v=[1 0 0 0 0 0 0];  
    errors=[errors v(p)];  
end
```

The function `randperm` generates a random permutation of the numbers 1 through 7. The vector `v(p)` applies the permutation to the entries of the vector `v`, which has exactly one entry that is 1. The result is that the vector `errors` contains exactly one entry that is 1 in each sequence from $7n + 1$ to $7(n+1)$.

Running a Simulation with Imported Error Data

When you run a simulation, the bit error rate is zero because the Hamming code can correct one error in each codeword.

To test the code with an error vector that creates two errors in each codeword, change the vector `v` to `v=[1 1 0 0 0 0 0]` in the preceding code.

Setting Sample Times and Samples per Frame

It is important to set the **Sample time** and **Samples per frame** parameters correctly in the Signal From Workspace block, so that the block has the same frame size and frame period as the Hamming Encoder block. This ensures that errors coming from the Signal From Workspace block are synchronized with channel symbols coming from the Hamming Encoder block. To determine the correct sample time, use the following relationship:

$$\text{Sample time} = \frac{\text{Frame period}}{\text{Samples per frame}}$$

The frame size of the signal coming from the Hamming Encoder block is 7. You set the frame size by the **Codeword length** parameter in the block's dialog box. So you should set the **Samples per frame** parameter in the Signal From Workspace block to 7.

The frame period of the Hamming Encoder block is 4, because the Bernoulli Binary Generator block has a **Sample time** of 1 and a **Samples per frame** of 4. So set the **Sample time** parameter in the Signal From Workspace block to 4/7 so that the frame period of the block is 4.

If you are not sure what the frame sizes and frame periods of signals in the model are, you can display them using a Probe block, as described in “Using a Probe Block to Determine Symbol Period” on page 2-45. To do this, attach two Probe blocks, one to the line leading out of the Hamming Encoder block and one to the line leading out of the Signal From Workspace block. In the dialog boxes for both Probe blocks, clear the check boxes next to **Probe complex signal** and **Probe signal dimensions**. Next, attach Terminator blocks to the output ports of the Probe blocks. Then select **Update diagram** from the **Edit** menu. The model should appear as in the following figure.

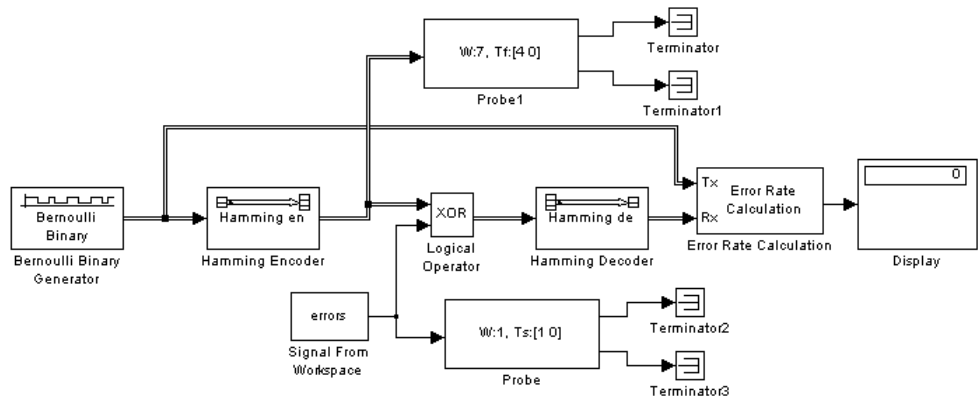

Hamming Code Model with Probe Blocks

Both Probe blocks should display a frame size of 7 and a frame period of 4.

A quick way to check whether the frame periods of two signals are the same is to select **Sample time colors** from the **Port/signal displays** submenu

of the **Format** menu. See “Using Sample Time Colors to Check Sample Times” on page 2-53.

Learning More

In this section...
“Online Help” on page 3-19
“Demos” on page 3-19
“The MathWorks Online” on page 3-20

Online Help

To find online documentation, select **Product Help** from the **Help** menu in the MATLAB desktop. This launches the Help browser. For a more detailed explanation of any of the topics covered in this book, see the documentation listed under Communications Blockset in the left pane of the Help browser.

Besides this book, *Communications Blockset Getting Started Guide*, the online documentation contains the following topics:

- “Using the Libraries” describes each of the core libraries of the blockset.
- “Modeling Communication Systems” illustrates techniques for modeling a full communication system.
- “Block Reference” provides descriptions of the Communications Blockset libraries and lists the blocks in them.
- “Blocks — Alphabetical List” provides a detailed description of the blocks in Communications Blockset software in alphabetical order.

The Help Navigator, in the left pane of the Help browser, supports string searches. You can specify strings and the online manuals that you want to search. To begin a search, click the **Search** tab. To view the index for the documentation, click the **Index** tab.

Demos

To see more Communications Blockset examples, type

```
demo
```

at the MATLAB prompt. This opens the MATLAB Demo window. Double-click **Blocksets** and then select **Communications** to list the available demos.

The MathWorks Online

To find the Communications Blockset documentation on the MathWorks Web site, point your Web browser to

`http://www.mathworks.com/access/helpdesk/help/helpdesk.shtml`.

List of Examples

Use this list to find examples in the documentation.

Getting Started

- “Running a Simulink Model” on page 2-2
- “Building a Simple Model” on page 2-11
- “Building a Channel Noise Model” on page 2-24
- “Modeling a Channel with Modulation” on page 2-39
- “Reducing the Error Rate with a Cyclic Code” on page 2-42
- “Building a Frequency-Shift Keying Model” on page 2-47
- “Building a Convolutional Code Model” on page 2-54
- “Sending Data to the MATLAB Workspace” on page 3-2
- “Running Multiple Simulations” on page 3-8
- “Importing Data from the MATLAB Workspace” on page 3-13

A

adding noise to models 2-19

B

binary phase shift keying (BPSK) 2-40

block libraries 2-13

block masks 2-7

block parameters 2-7

blocks

connecting 2-15

labeling 2-33

moving into model 2-14

BPSK modulation example 2-39

building models 2-11

C

channel coding 2-24

channel noise example 2-24

commstartup usage 2-12

connecting blocks 2-15

constellation 2-4

continuous signals 2-22

convolutional code example 2-54

convolutional encoder 2-55

cyclic code example 2-42

D

delays 2-51

calculating 2-51

discrete signals 2-22

drawing a branch line 2-28

E

error rate

displaying 2-6

errors

displaying in a scope 2-34

simulating by importing data 3-15

F

Find Delay block

FSK model 2-51

frame-based processing 2-22

frames 2-22

displaying sizes of 2-34

frequency-shift keying (FSK) 2-47

FSK model 2-47

H

Hamming code example 2-30

I

importing data from MATLAB workspace 3-13

L

labeling blocks 2-33

Library Browser 2-13

M

models

building 2-11

multirate 2-52

running 2-18

saving 2-21

moving blocks into a model 2-14

multirate models 2-52

N

noise

adding to models 2-19

O

online help 3-19

P

plotting results of multiple simulations 3-10

Q

quadrature amplitude modulation (QAM) 2-4

R

running simulations 2-5

S

sample time colors 2-53

sample times 2-22

 setting 3-16

sample-based processing 2-22

samples per frame 2-22

 setting 3-16

saving models 2-21

sending data to MATLAB workspace 3-2

signals

 continuous 2-22

 discrete 2-22

 displaying in a scope 2-18

 simulating by importing data 3-13

simulation parameters 2-17

simulations

 plotting results of 3-10

 running 2-5

 running from command line 3-7

Simulink libraries 2-13

Simulink Library Browser 2-13

symbol periods 2-44